

LFP-12.8-100

Lithium iron phosphate battery



LITHIUM SERIES

Characteristics

Electrical		
Nominal voltage	12.8V	
Nominal capacity at 5 hours rate (25°C)	100Ah	
Energy	1280Wh	
Charge Efficiency at 0.2C (25°C)	99.5%	
Discharge Efficiency at 1C (25°C)	96-99%	
Approx. internal resistance (25°C)	≤14.0 mΩ	
Cycle life / 0.2C 100% D.O.D	>3000 cycles	
Capacity affected by temperature	40°C	101%
	25°C	100%
	0°C	90%
	-10°C	75%
Mechanical		
Dimensions	Length	339±2mm (12.99inch)
	Width	185±2mm (6.73inch)
	Height	215±2mm (8.43inch)
	Total height	218±2mm (8.66inch)
Terminal type	T16	
Torque	2.3±2.5N.m	
Weight	12.5kg (39.24lbs)±4%	
Water & Dust resistance	IP65	
Battery container ABS UL94-HB	V-0 optional	
Cell strings	4 strings	
Temperature		
Nominal operating temperature	25°C±3 (77±5°F)	
Operating temperature range	Discharge	-20°C~60°C (-4°F~140°F)
	Charge	0°C~45°C (32°F~113°F)
	Storage	0°C~40°C (32°F~104°F)
Charging		
Charging voltage at 25°C	14.6V	
Standard charge mode (25°C±2°C, <75%RH)	0.2CA Constant Current to 14.6V, then Constant Voltage 14.6V until the current drops to 0.02CA. Rest 30 minutes, before use.	
Nominal charging current	20A	
Maximum charging current	50A	
Charging cut-off voltage	14.6V	
Discharging		
Continuous discharge current	100A	
Maximum pulse discharge current (<100ms)	300A	
Discharge cut-off voltage	11.2V	
Self discharge rate (25°C)	≤3%/month	
Communication & connection		
Communication protocol (optional)	RS485 (standard none)	
SOC (optional)	LED/Bluetooth	
Maximum modules in paralel or series	1 string 1 parallel	

Overview

Lithium-Iron Phosphate batteries offer superb improvement in characteristics compared to lead-acid technology. Due to the extreme cycle and calendar life, LiFePO₄ batteries are an excellent long-term investment for your applications. Powerful, lightweight, safe, and smart, the Lithium-Iron Phosphate batteries are the future of the energy storage you can have right now.

Features

Longer cycle life - Up to 15 times longer cycle life and 5 times longer float/calendar life than lead-acid batteries.

More capacity - Provides up to 100% of usable energy.

Lightweight - 60% lighter than lead-acid batteries.

High discharge rate - Ability to fully discharge the battery at a high rate of discharge.

Fast charging - Charges much faster than conventional sealed lead-acid batteries.

Long cycle life - More than 3000 cycles at 100% depth of discharge.

Intelligent BMS - The battery management system monitors and adapts to battery conditions to maximize performance and safety.

Dimensions & Terminal Type (mm)

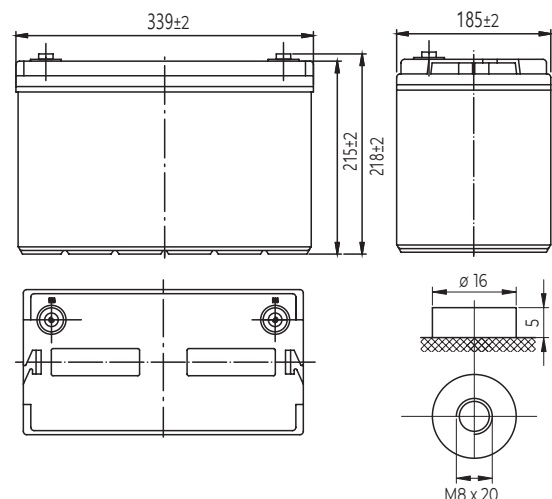

T16

LFP-12.8-100

Lithium iron phosphate battery

LITHIUM

SERIES

Discharge characteristics (25°C)

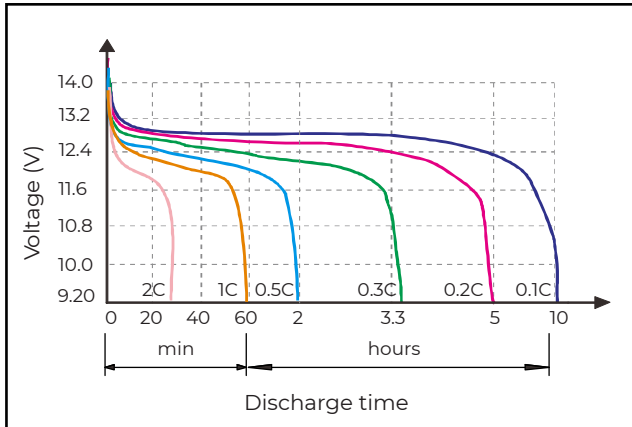

Temperature effects on discharge (0.5C)

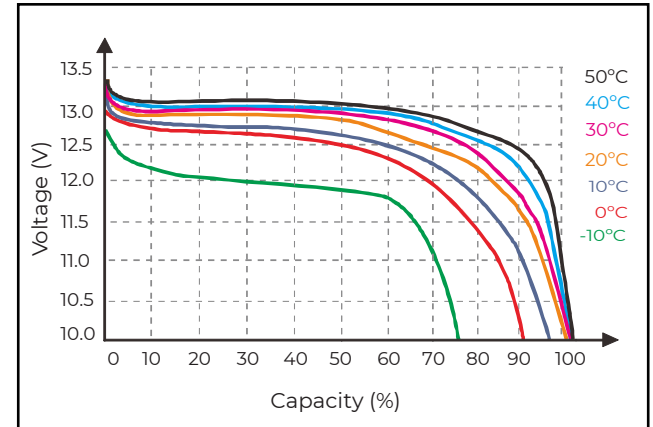

Charging Time on S.O.C. (25°C)

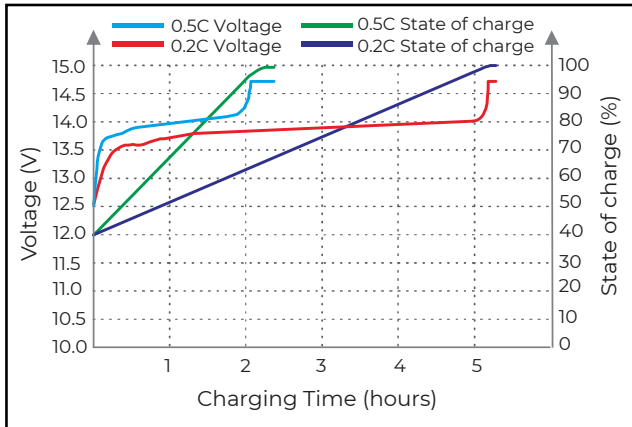

Charge characteristics (25°C)

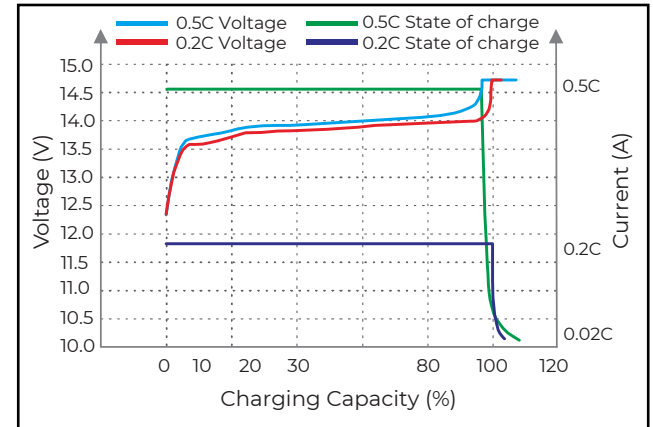

Cycle life on D.O.D. (25°C)

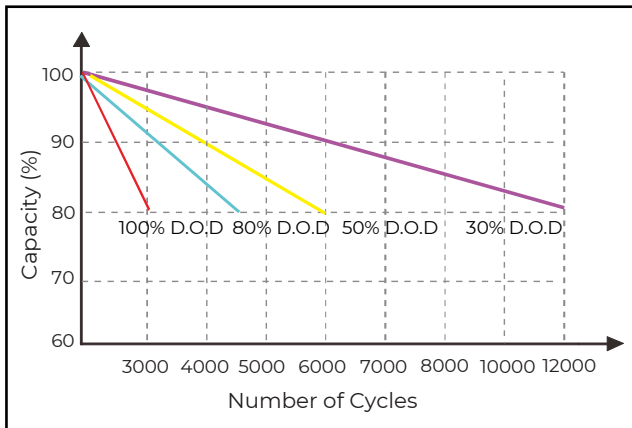

Self discharge characteristics

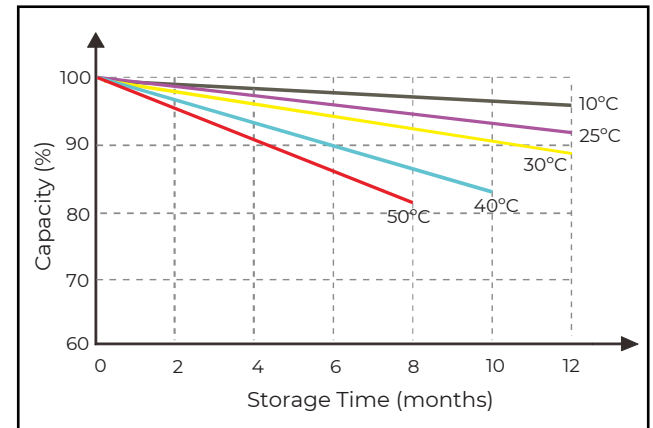

D.O.D. - depth of discharge
S.O.C. - state of charge