

FIBRAIN ®

FOOC

Fiber Optic Cables

INFORMATION

Application
FOC Parameters
Low Loss Fibers
SM/MM Bendsafe Fibers
Fiber and Cables Information
Fiber Identification

Page 5
Page 5
Page 6
Page 7
Page 9
Page 10
Page 11

5

DATAKOM

Furcation tube FSMX
Buffer BFR
Simplex SMX
DC-PRIM-14
DC-PRIM-20
DC-PRIM
DC-DRIM
Duplex ZIP
DC-T40
LDC
LBR
EXO-FU
EXO-FI
EXO-GU
EXO-GO
EXO-GI
BDC-MSA

Page 17
Page 17
Page 18
Page 19
Page 21
Page 22
Page 23
Page 24
Page 25
Page 26
Page 27
Page 28
Page 29
Page 30
Page 31
Page 32
Page 33
Page 34

17

FTTH

VC-D20
VC-D30
VC-D40
VC-DCY
Resibend® Cables
VC-D30 Resibend®
VC-D30 Resibend Plus®
Easy Section Module® Cables
VC-D20 Easy Section Module®
VC-D30 Easy Section Module®
VC-D40 Easy Section Module®
DC-PRIM
EAC-RAs
EAC-RAm
DAC-BURRY
DAC-BURRY-G
VC-T601
VC-T60

Page 35
Page 37
Page 38
Page 39
Page 40
Page 41
Page 42
Page 43
Page 44
Page 45
Page 46
Page 47
Page 48
Page 49
Page 50
Page 51
Page 52
Page 53
Page 54

35

MICRODUCT

MK-AX2

MK-LX4

MK-LX5

MK-LXS6/7/8

MK-LXS9/10

MK-LX6

MK-LX7

MK-LX8

MK-LX9

MK-LX11

Page 55

Page 57

Page 58

Page 59

Page 60

Page 61

Page 62

Page 63

Page 64

Page 65

Page 66

55

TELECOM DUCT

BDC-MSA

BDC-MIB

BDC-C0

BDC-CI

BDC-CK

BDC-DI

BDC-DK

DDC-SI

DDC-CI

MDC-FM

Page 67

Page 68

Page 69

Page 70

Page 71

Page 72

Page 73

Page 74

Page 75

Page 76

Page 77

67

ARMORED CABLES

SSC-CI

SSC-T30U

SSC-T30I

DSC-CI

Page 78

Page 79

Page 80

Page 81

Page 82

78

TELECOM AERIAL

Aero-DR03

Aero-DF03

Aero-DDF03

Aero-AS02 2.0 mm

Aero-AS03 2.0 mm

Aero-AS03 2.5 mm

Aero-AS04 2.0 mm

Aero-AS04 2.5 mm

Aero-AS06 2.0 mm

Aero-AS06 2.5 mm

Aero-AS09 2.5 mm

Aero-AS12 2.5 mm

Aero-AS14 2.5 mm

Page 83

Page 84

Page 85

Page 86

Page 87

Page 88

Page 89

Page 90

Page 91

Page 92

Page 93

Page 94

Page 95

Page 96

83

SPECIAL CABLE DESIGNS

FTTA-DAC

BDC-CIP 1.5 mm²

BDC-CIP 0.5 mm² H05V-U

BDC-CIP 0.75 mm² H05V-U

BDC-CIP 1.00 mm² H05V-U

BDC-DIP 1.50 mm² H07V-U

BDC-DIP 2.50 mm² H05V-U

BDC-DID 0.80 mm

Page 97

Page 98

Page 99

Page 100

Page 101

Page 102

Page 103





































Page 104

Page 105

82

Information

SYMBOLS

Mechanical features	 Basic Rodent Protection	 High Rodent Protection	 Rodent Protection Extreme	 Blowing installation
	 Flexible	 Last mile connection outdoor	 Aerial	 Hi-crush
	 Direct buried	 Duct	 Microduct Generation 1	 ETR
	 Optimal Diameter			
Branch of business	 Industrial	 Mining	 Military	 Oil resistance
	 Ship and offshore	 Robotic	 Windfarms	 Datacenter
	 Datacom	 Telecom	 FTTH	 FTTA
Design features	 Semi-tight	 Easy-strip	 LSOH	 Compact design
	 Flexible	 Multifiber connectors termination	 Easy to terminate	 Last Mile Indoor Connection
	 Bendsafe	 Low Friction	 Hybrid FO + Power	

SINGLE-MODE FIBER TYPES

Fiber type ITU-IT		Maximum attenuation for uncabled fibers IL [dB/km]						
		1310 nm	1383 nm	1410 nm	1450 nm	1490 nm	1550 nm	1625 nm
G.652D	Standard single mode telecommunication fiber with zero water-peak attenuation	≤0.34	≤0.31	-	-	≤0.24	≤0.20	≤0.23
G.652D LL	Premium single mode fiber low loss with zero water-peak and lower attenuation in whole bandwidth	≤0.32	≤0.31	-	-	≤0.21	≤0.18	≤0.20
G.655 – A,B,C,D	Long distance single mode fiber with non-zero dispersion shifted (NZDSF) for CWDM and DWDM system 10G and future 40G or 100G	-	≤0.40	≤0.32	≤0.26	-	≤0.19	≤0.21
G.656 – A,B,C,D	Long distance single mode fiber with non-zero dispersion shifted (NZDSF) for CWDM and DWDM system 10G and future 40G or 100G	-	≤0.40	≤0.32	≤0.26	-	≤0.19	≤0.21
G.657A1	Bend insensitive fiber fully compatible with G.652D standard, bend radius 10-15 mm	≤0.35	≤0.35	-	-	≤0.24	≤0.20	≤0.23
G.657A2	Bend insensitive fiber fully compatible with G.652D standard, bend radius 7.5 mm	≤0.35	≤0.35	-	-	≤0.24	≤0.20	≤0.23
G.657B3	Bend insensitive fiber fully compatible with G.652D standard, bend radius 5 mm	≤0.35	≤0.35	-	-	≤0.24	≤0.20	≤0.23
G.657B3 Plus	Bend insensitive fiber, compatible with G.652D standard, for connectorization application, bend radius 2.5 mm	≤0.35	≤0.35	-	-	≤0.24	≤0.21	≤0.23

MULTIMODE FIBER TYPES

Fiber type ITU-T	Overfilled modal bandwidth [MHz/km]		Link Lengths [m]			Attenuation [dB/km]		Bending loss 2 turns [dB]				Bending loss 10 turns [dB]	
	850 nm	1300 nm	1GBase-SR	10GBase-SR	40GBase-SR4/100GBase-SR10	850 nm	1300 nm	Radius = 7.5 mm		Radius = 15 mm		Radius = 30 mm	
								850 nm	1300 nm	850 nm	1300 nm	850 nm	1300 nm
62.5/125 OM1	≥ 160	≥ 500	275	-	-	2.6	0.5	-	-	-	-	-	≥ 0.5
50/125 OM2 Bend Insensitive	≥ 500	≥ 500	600	83	-	2.3	0.5	≥ 0.2	≥ 0.5	≥ 0.1	≥ 0.3	-	-
50/125 OM3 Bend Insensitive	≥ 1500	≥ 500	1000	300	140*	2.4	0.5	≥ 0.2	≥ 0.5	≥ 0.1	≥ 0.3	-	-
50/125 OM4 Bend Insensitive	≥ 3500	≥ 500	1100	550	170*	2.4	0.6	≥ 0.2	≥ 0.5	≥ 0.1	≥ 0.3	-	-

* Maximum cabled fiber attenuation 3.0 dB/km at 850 nm, maximum total connector loss of 1.0 dB and VCSELs maximum RMS spectral width of 0.29 nm (according to IEEE 10GbE model: http://grouper.ieee.org/groups/802/3/ae/public/adhoc/serial_pmd/documents/10GEPBud3_1_16a.xls).

BENDING LOSS

Fiber type	Mandrel R=30 mm 100 turns 1550/1625 nm ≤0.03 dB	Mandrel R=25 mm 1310/1550 nm 100 turns 0.03 dB	Mandrel R=15 mm 10 turn 1550 nm ≤0.25 dB 1625 nm ≤1.0 dB
G.652D	Mandrel R=30 mm 100 turns 1550/1625 nm ≤0.03 dB	Mandrel R=25 mm 1310/1550 nm 100 turns 0.03 dB	Mandrel R=15 mm 10 turn 1550 nm ≤0.25 dB 1625 nm ≤1.0 dB
G.652D LL	Mandrel R=30 mm 100 turns 1550/1625 nm ≤0.03 dB	Mandrel R=25 mm 1310/1550 nm 100 turns 0.03 dB	Mandrel R=15 mm 10 turn 1550 nm ≤0.25 dB 1625 nm ≤1.0 dB
G.655 – A.B.C.D	Mandrel R=30 mm 100 turns 1550/1625 nm ≤0.05 dB	Mandrel R=15 mm 1550/1625 nm 1 turn ≤0.5 dB	
G.656 – A.B.C.D	Mandrel R=30 mm 100 turns 1550/1625 nm ≤0.05 dB	Mandrel R=15 mm 1550/1625 nm 1 turn ≤0.5 dB	
G.657A1	Mandrel R=15 mm 10 turns 1550 nm ≥0.20 dB. 1625 nm ≤0.50 dB	Mandrel R=10 mm 1 turn 1550 nm ≥0.50 dB. 1625 nm ≤1.50 dB	
G.657A2	Mandrel R=15 mm 10 turns 1550 nm ≥0.03 dB. 1625 nm ≤0.10 dB	Mandrel R=10 mm 1 turn 1550 nm ≥0.10 dB. 1625 nm ≤0.2 dB;	Mandrel R=7.5 mm 1 turn 1550 nm ≥0.50 dB. 1625 nm ≤1.0 dB
G.657B3	Mandrel R=10 mm 1 turn 1550 nm ≥0.03 dB. 1625 nm ≤0.10 dB	Mandrel R=7.5 mm 1 turn 1550 nm ≥0.05 dB. 1625 nm ≤0.15 dB	Mandrel R=5 mm 1 turn 1550 nm ≥0.10 dB. 1625 nm ≤0.30 dB
G.657B3 Plus	Mandrel R=5 mm 1 turn 1550 nm ≥0.10 dB. 1625 nm ≤0.20 dB	Mandrel R=2.5 mm 1 turn 1550 nm ≥0.20 dB. 1625 nm ≤0.30 dB	

❖ Fiber types and applications

Tight 900 μm fiber

Possibility to remove the 900 μm coat at the distance of 3-5 cm

Semi-tight 900 μm fiber

Possibility to remove the 900 μm coat at the distance of 20-40 cm

Easy strip 900 μm fiber

Possibility to remove the 900 μm coat at the distance more than 100 cm

❖ Available bend radius

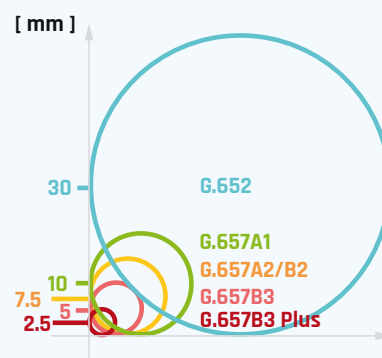

At present, low loss and pure quartz optic fibers with max. 0.17 dB/km attenuation at 1550 nm wavelength and max. 0.31 dB/km at 1310 nm wavelength are ready for use. Low loss and pure quartz optic fibers have at least 0.02 dB/km lower spectral attenuation in comparison to the standard ones G.652D. In such fibers, the retention of flat spectral characteristics within the transmission windows provide the possibility of achieving substantially smaller deviations of attenuation:

- 1310 nm (+ 20 nm / -35 nm) wavelength – max. deviation is 0.03 dB/km
- 1550 nm (+ 25 nm / -25 nm) wavelength – max. deviation is 0.02 dB/km with the retention of 1625 nm attenuation 0.20 dB/km.

The chromatic dispersion complies with ITU-T G.652 and the polarizing at the level of ≤ 0.04 ps/ $\sqrt{\text{km}}$ of these fibers provides the possibility of using such fibers in high-speed systems e.g. transmission of 10 GBit/s or even higher. Low loss fibers which are obtained in the pure quartz technology can work properly in telecommunication networks at the distance of even thousand kilometers far, which significantly limits the number of necessary amplifiers and repeaters in a fiber optic connection.

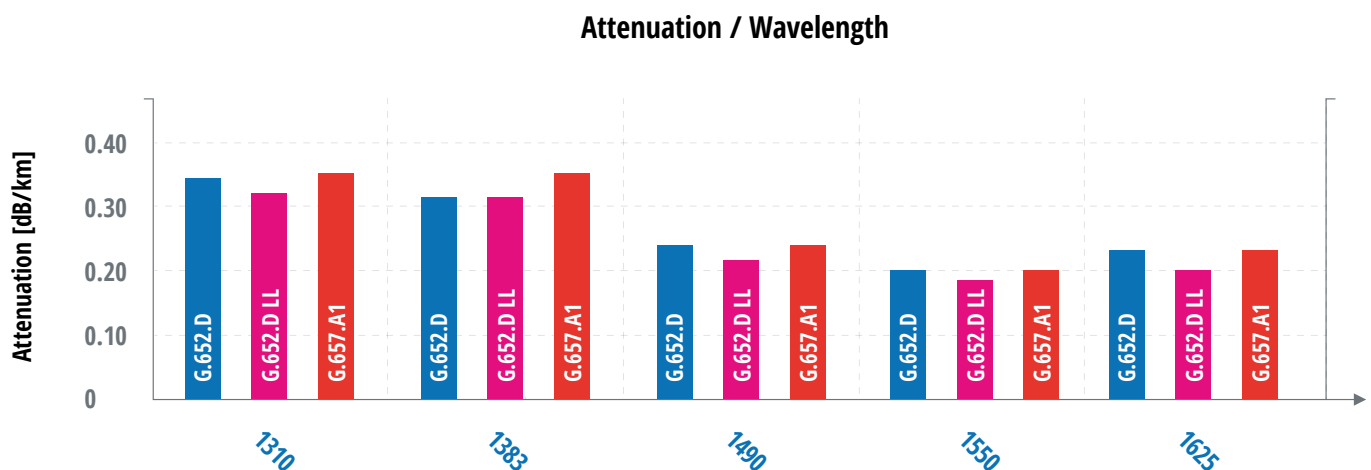

Performance Specifications

Parameter	Value			
Attenuation [dB/km]				
1310 nm	≤ 0.32			
1383 ± 3 nm	≤ 0.32			
1490 nm	≤ 0.21			
1550 nm	≤ 0.18			
1625 nm	≤ 0.20			
Attenuation Difference [dB/km]				
The attenuation from λ1 [nm] to λ2 [nm] shall not exceed the attenuation at λ3 [nm] by more than Δ	λ1	λ2	λ3	Δ
	1285	1330	1310	0.03
	1525	1575	1550	0.02
Point Discontinuity [dB]				
1310 nm and 1550 nm	≤ 0.05			
Optical Return Loss [dB]				
Absolute value at all points along the fiber	≥ 60			
Attenuation with Bending [dB]	Turns	mm	nm	dB
	1	32	1550	≤ 0.03
	100	50	1310	≤ 0.03
	100	50	1550	≤ 0.03
	100	60	1625	≤ 0.03
Cable Cutoff Wavelength [nm]	≤ 1260			
Mode Field Diameter [μm]				
1310 nm	9.2±0.4			
1550 nm	10.4±0.5			
Dispersion [ps/(nm•km)]				
1550 nm	≤ 18.0			
1625 nm	≤ 22.0			
Zero Dispersion Wavelength - λ₀ [nm]	1304 to 1324			
Zero Dispersion Slope - S₀ [ps/(nm²•km)]	≤ 0.092			
Polarization Mode Dispersion (ps/√km)				
Individual fiber	≤ 0.1			
Link value	≤ 0.04			
Environmental / Attenuation Effects (dB/km)	1310 / 1550 / 1625 nm			
Temperature Dependence (-60°C to +85°C)	≤ 0.05			
Temperature-Humidity Cycling (-10°C to +85°C with humidity cycling up to 98% RH)	≤ 0.05			
Dry Heat Soak (85±2°C)	≤ 0.05			
Water Immersion (23±2°C)	≤ 0.05			
Damp Heat Soak (85±2°C, 85% RH, 30 Days)	≤ 0.05			
Fiber Curl	≤ 0.05			
Deflection for 10 mm overhang (μm)	≤ 12.4			
Corresponding radius of curvature (meters)	≥ 4.0			
Minimum Strength (by Proof Test)	0.69 GPa (100 kpsi)			
Operating Temperature Range	-60°C to +85°C			

Available bend radius

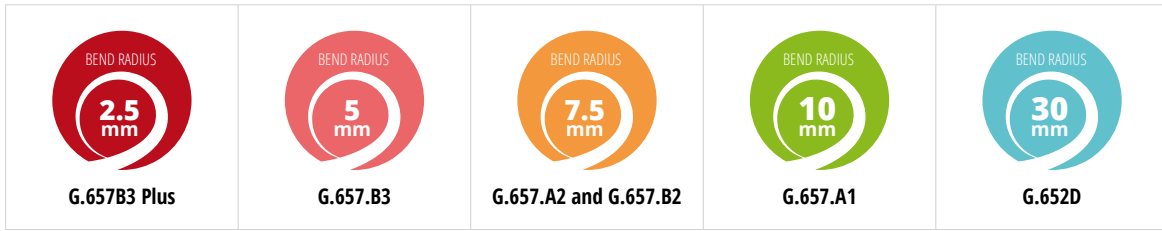

Bendsafe SM Fibers

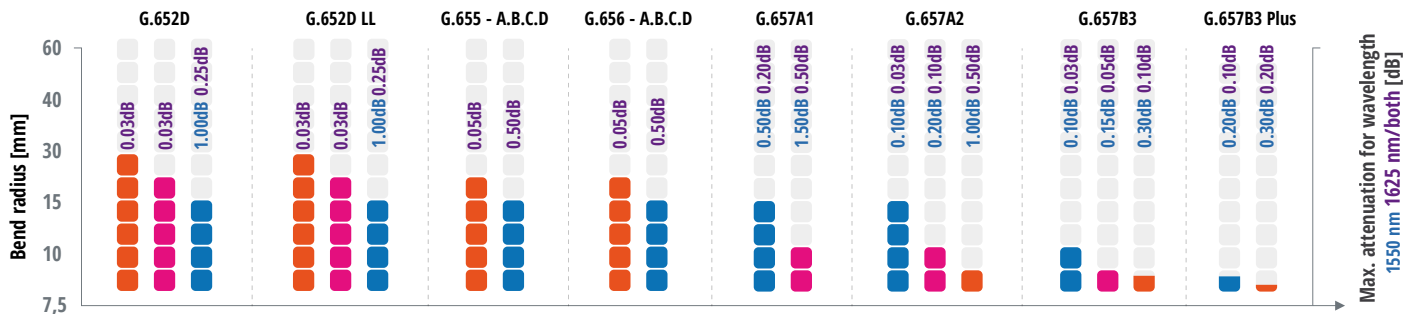

Bendsafe MM Fibers

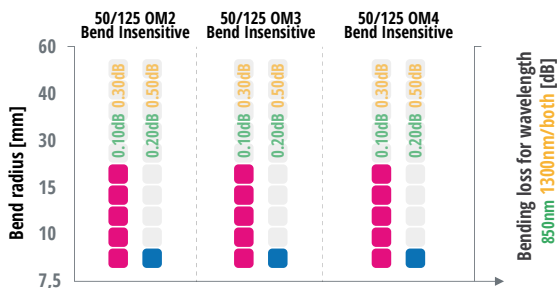

Post-production fiber parameters

Type	Attenuation [dB/km]			
	1310	1550	850	1300
Low Loss (LL)	0.34	0.22	-	-
Telecom	0.35	0.25	-	-
Standard	0.40	0.30	-	-
Datacom	0.40	0.30	3.0 (3.5*)	1.0 (1.5*)

* values for OM1

Stripping

Tight buffer

Tight 900 μm fiber

Possibility to remove the 900 μm coat at the distance of 3-5 cm

Semi-tight

Semi-tight 900 μm fiber

Possibility to remove the 900 μm coat at the distance of 20-40 cm

Easy strip

Easy strip 900 μm fiber

Possibility to remove the 900 μm coat at the distance more than 100 cm

Tight buffer vs. Loose tube

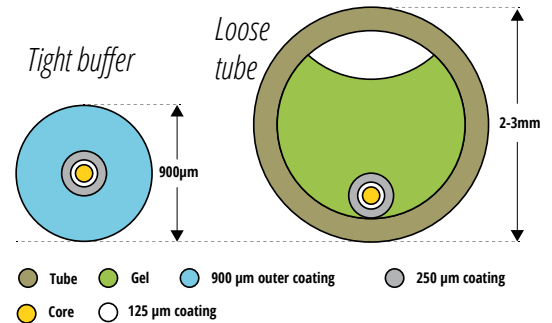

FIBER COLOR CODES IN LOOSE TUBE CABLE DESIGN

Other colors available on demand

T-TELECOM (ACCORDING TO IEC 60304)

1-12	1	2	3	4	5	6	7	8	9	10	11	12
Code												
Color	red	green	blue	white	violet	orange	grey	yellow	brown	pink	black	aqua
13-24	13	14	15	16	17	18	19	20	21	22	23	24
Code												
Color	red	green	blue	white	violet	orange	grey	yellow	brown	pink	natural	aqua

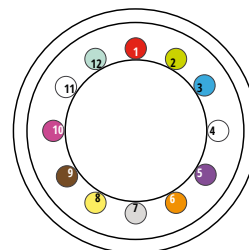

*In 24-fiber tube construction colors will be repeated to facilitate identification, fibers 13-24 will have rings every 25 cm

T1-TELECOM (ACCORDING TO IEC 60304 TABLE 3 & ZN-11/TPSA-005-02)

1-12	1	2	3	4	5	6	7	8	9	10	11	12
Code												
Color	red	blue	white	green	violet	orange	grey	yellow	brown	pink	black	aqua
13-24	13	14	15	16	17	18	19	20	21	22	23	24
Code												
Color	red	blue	white	green	violet	orange	grey	yellow	brown	pink	natural	aqua

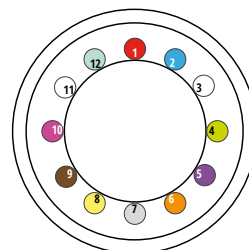

*In 24-fiber tube construction colors will be repeated to facilitate identification, fibers 13-24 will have rings every 25 cm

T2-TELECOM (ACCORDING TO EIA 598A)

1-12	1	2	3	4	5	6	7	8	9	10	11	12
Code												
Color	blue	orange	green	brown	grey	white	red	black	yellow	violet	pink	aqua
13-24	13	14	15	16	17	18	19	20	21	22	23	24
Code												
Color	blue	orange	green	brown	grey	white	red	natural	yellow	violet	pink	aqua

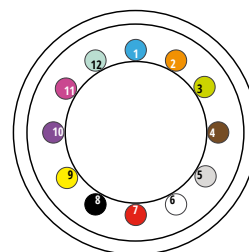

*In 24-fiber tube construction colors will be repeated to facilitate identification, fibers 13-24 will have rings every 25 cm

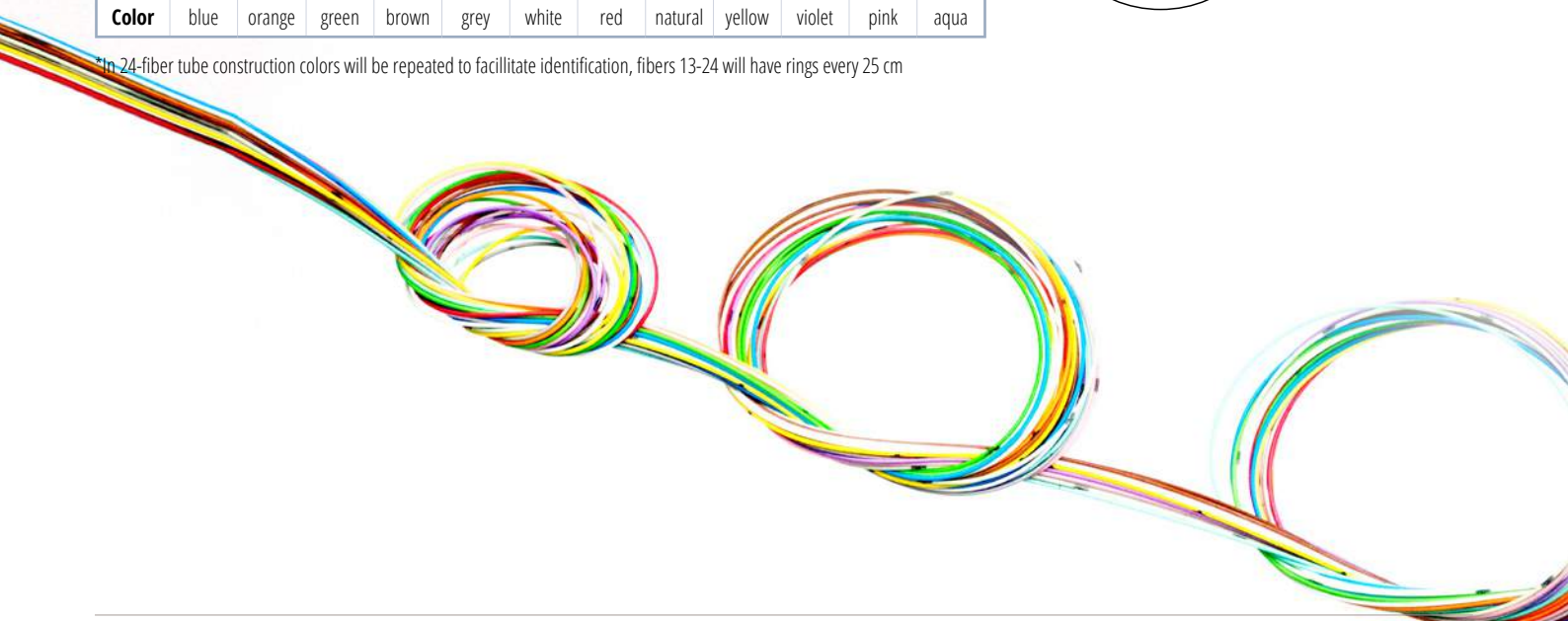

LOOSE TUBE COLOR CODES IN LOOSE TUBE CABLE DESIGN

Other colors available on demand

T-TELECOM - LOOSE TUBE IN CABLE (ACCORDING TO IEC60304):

Tube	1	2	3	4	5	6	7	8	9	10	11	12
Code	■	■	■	■	■	■	■	■	■	■	■	■
Color	red	green	blue	white	violet	orange	grey	yellow	brown	pink	black	aqua

**In cable with a multi-layer construction color of the tubes will be repeated in second layer

***In case of lower fiber count some tubes can be replaced by fillers

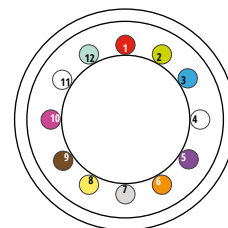

T1-TELECOM - LOOSE TUBE IN CABLE (ACCORDING TO IEC 60304 TABLE 3 & ZN-11/TPSA-005-02)

Tube	1	2	3	4	5	6	7	8	9	10	11	12
Code	■	■	■	■	■	■	■	■	■	■	■	■
Color	red	blue	white	green	violet	orange	grey	yellow	brown	pink	black	aqua

**In cable with a multi-layer construction color of the tubes will be repeated in second layer

***In case of lower fiber count some tubes can be replaced by fillers

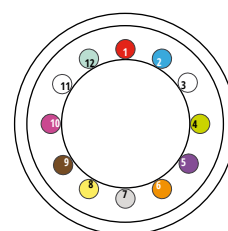

T2-TELECOM - LOOSE TUBE IN CABLE (ACCORDING TO EIA 598A)

Tube	1	2	3	4	5	6	7	8	9	10	11	12
Code	■	■	■	■	■	■	■	■	■	■	■	■
Color	blue	orange	green	brown	grey	white	red	black	yellow	violet	pink	aqua

**In cable with a multi-layer construction color of the tubes will be repeated in second layer

***In case of lower fiber count some tubes can be replaced by fillers

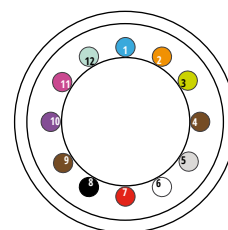

T3-TELECOM - LOOSE TUBE IN CABLE ACCORDING TO IEC 60304)

Tube	1	2	3	4	5	6	7	8	9	10	11	12	13	14	15
Code	■	■	■	■	■	■	■	■	■	■	■	■	■	■	■
Color	red	green	blue	white	violet	orange	grey	yellow	brown	pink	black	aqua	luminous red	patina green	signal blue

**In cable with a multi-layer construction color of the tubes will be repeated in second layer

***In case of lower fiber count some tubes can be replaced by fillers

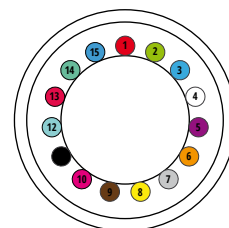

E-TELECOM - LOOSE TUBE IN CABLE (ACCORDING TO EIA 598A)

Tube	1	2	3	4	5	6	7	8	9	10	11	12
Code	■	■	■	■	■	■	■	■	■	■	■	■
Color	red	green	white	white	white	white	white	white	white	white	white	white

**In cable with a multi-layer construction color of the tubes will be repeated in second layer

***In case of lower fiber count some tubes can be replaced by fillers

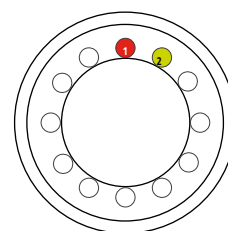

FIBER, BUFFER AND TUBES COLOR CODES FOR DATAKOM CABLES RANGE

Other colors available on demand

D-DATAKOM (ACCORDING TO DIN VDE 0888 & IEC 60304)

Fiber in buffer

1-12	1	2	3	4	5	6	7	8	9	10	11	12
Fiber												
Buffer												
Color 250/900/600 μm	red	green	blue	yellow	white	grey	brown	violet	aqua	black	orange	pink
13-24	13	14	15	16	17	18	19	20	21	22	23	24
Fiber												
Buffer												
Color 250 μm	red	green	blue	yellow	white	grey	brown	violet	aqua	natural	orange	pink
Color* 600/900 μm	red	green	blue	yellow	white	grey	brown	violet	brown	dark green	orange	pink

*Buffer with black mark to identify fibers 13-24



Fibers in tubes

1-12	1	2	3	4	5	6	7	8	9	10	11	12
Code												
Color	red	green	blue	yellow	white	grey	brown	violet	aqua	black	orange	pink
13-24	13	14	15	16	17	18	19	20	21	22	23	24
Code												
Color	red	green	blue	yellow	white	grey	brown	violet	aqua	natural	orange	pink

*In 24-fiber tube construction colors will be repeated to facilitate identification, fibers 13-24 will have rings every 25 cm

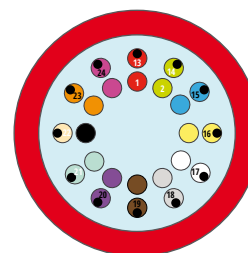

Loose tubes in cables

Tube	1	2	3	4	5	6	7	8	9	10	11	12
Code												
Color	red	green	blue	white	violet	orange	grey	yellow	brown	pink	black	aqua

**In cable with a multi-layer construction color of the tubes will be repeated in second layer

***In case of lower fiber count some tubes can be replaced by fillers

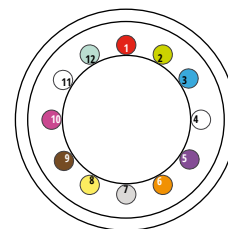

FIBER AND BUFFER COLOR CODES FOR DATACOM CABLES RANGE

Other colors available on demand

D1-DATACOM (ACCORDING TO IEC 60304 ; TIA/EIA 598-A ; TIA/EIA 598-C /DATA CENTER CABLES)

Fiber in buffer

1-12	1	2	3	4	5	6	7	8	9	10	11	12
Fiber												
Buffer												
Color 250/900/600 μm	blue	orange	green	brown	grey	white	red	black	yellow	violet	pink	aqua
13-24	13	14	15	16	17	18	19	20	21	22	23	24
Fiber												
Code												
Color 250 μm	blue	orange	green	brown	grey	white	red	natural	yellow	violet	pink	aqua
Color* 600/900 μm	blue	orange	green	brown	grey	white	red	dark green	yellow	violet	pink	aqua

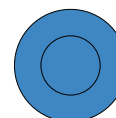

*Buffer with black mark to identify fibers 13-24

Fibers in tubes

1-12	1	2	3	4	5	6	7	8	9	10	11	12
Code												
Color	blue	orange	green	brown	grey	white	red	black	yellow	violet	pink	aqua
13-24	13	14	15	16	17	18	19	20	21	22	23	24
Code												
Color	blue	orange	green	brown	grey	white	red	natural	yellow	violet	pink	aqua

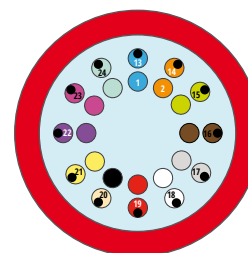

*In 24-fiber tube construction colors will be repeated to facilitate identification, fibers 13-24 will have rings every 25 cm

Loose tubes in cables

Tube	1	2	3	4	5	6	7	8	9	10	11	12
Code												
Color	red	green	blue	white	violet	orange	grey	yellow	brown	pink	black	aqua

**In cable with a multi-layer construction color of the tubes will be repeated in second layer

***In case of lower fiber count some tubes can be replaced by fillers

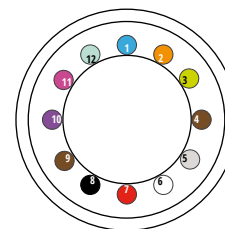

FIBER AND BUFFER COLOR CODES FOR FTTH CABLES RANGE

Other colors available on demand

F-FTTH (ACCORDING TO DIN VDE 0888 & IEC 60304)

1-12	1	2	3	4	5	6	7	8	9	10	11	12
Fiber												
Buffer												
Color 250 μm	red	blue	green	yellow	violet	white	orange	grey	brown	black	aqua	pink
Color 600/900 μm	red	blue	green	yellow	violet	white	orange	grey	brown	black	aqua	pink
13-24	13	14	15	16	17	18	19	20	21	22	23	24
Fiber												
Code												
Color 250 μm	red	blue	green	yellow	violet	white	orange	grey	brown	black	aqua	pink
Color* 600/900 μm	red	blue	green	yellow	violet	white	orange	grey	brown	dark green	aqua	pink

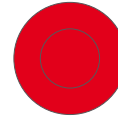

*Buffer with black mark to identify fibers 13-24

FIBRAIN COATINGS

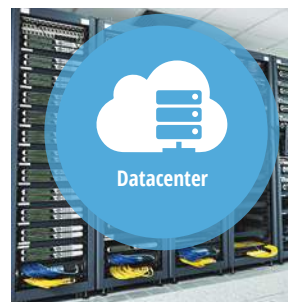
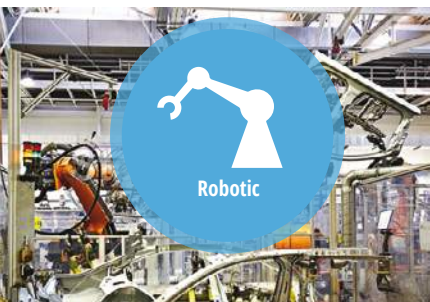

Coatings physical properties

PE *polyethylene*

Mechanical resistance



Temperature resistance



Chemical resistance



LSOH

Mechanical resistance



Temperature resistance



Chemical resistance



PVC *polyvinyl chloride*

Mechanical resistance



Temperature resistance



Chemical resistance



PUR *polyurethane*

Mechanical resistance



Temperature resistance



Chemical resistance



PA *polyamide*

Mechanical resistance



Temperature resistance



Chemical resistance



NBR *nitrile rubber*

Mechanical resistance



Temperature resistance



Chemical resistance



DATACOM FURCATION TUBE FSMX

Furcation tube FSMX 1.6-2.8 mm



Cable structure

1. LSOH outer jacket
2. Aramid yarns
3. Central tube 900 µm

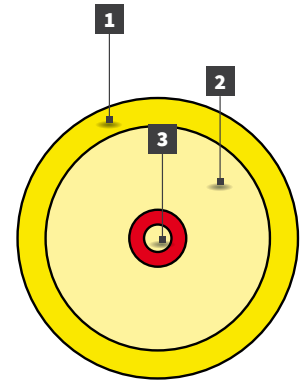

Flexible



Easy to terminate



Bendsafe



TRUE COLORS

Configuration

FSMX				
Version	Ø nominal ± 5% [mm]	Nominal weight ± 5% [kg/km]	Max. installation tension (ε=0.5%) [N]	Crush [N/10 cm]
FSMX 1.8	1.8/0.9/0.5	4	100	200
FSMX 2.8	2.8/0.9/0.5	8	350	300

Applications

- Distribution systems cable
- For patchcords and pigtaills
- Terminals connection

Jacket colors

Standard

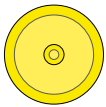

Yellow RAL 1021



White RAL 9010



Blue RAL 5015

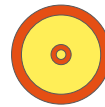

Orange RAL 2003

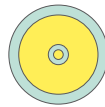

Aqua RAL 6027



Violet

Color codes

D-DATACOM (ACCORDING TO DIN VDE 0888 & IEC 60304) - Fibers & Buffers

1-12	1	2	3	4	5	6	7	8	9	10	11	12
Fiber	Red	Green	Blue	Yellow	White	Grey	Brown	Violet	Aqua	Black	Orange	Pink
Buffer	Red	Green	Blue	Yellow	White	Grey	Brown	Violet	Aqua	Black	Orange	Pink
Color 900 µm	red	green	blue	yellow	white	grey	brown	violet	aqua	black	orange	pink

Features

- LSOH with low coefficient of friction
- Aramid yarns
- Central tube 900 µm

Low-radius bending resistance SM

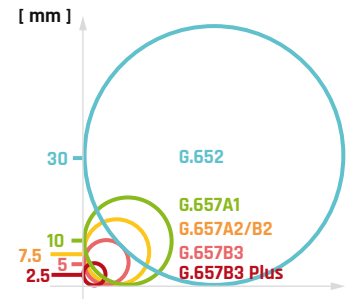

Operating temperature

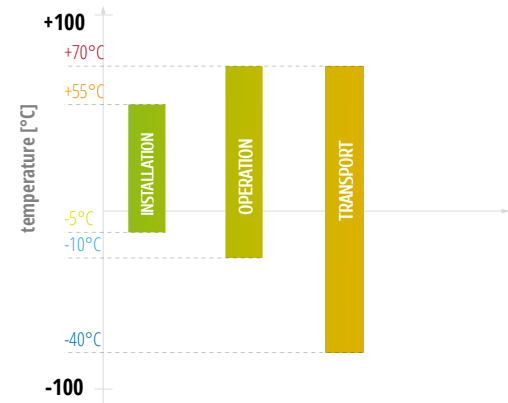

DATACOM BUFFER BFR

Buffer BFR 0.6 - 0.9 mm



Flexible



Easy to terminate



Semi-tight



Easy-strip



Bendsafe



Cable structure

1. Outer tight buffer tube 600/900 μm (LSOH)
2. Colored coating on fiber 250 μm
3. Optical fiber with cladding 125 μm

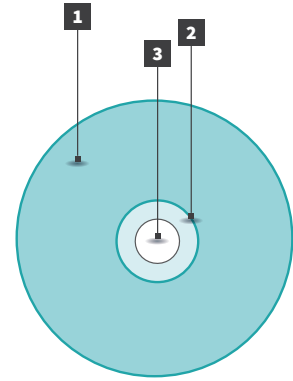

Configuration

BFR				
Version	Fiber qty	Ø nominal ± 5% [mm]	Max. installation tension ± 5% [N]	Crush [N/10cm]
1F	1	0.6	4	200
1F	1	0.9	5	

Applications

- Distribution systems cable
- For patchcords and pigtails
- Terminals connections

Available outer jacket colors



SM G.652D
Yellow RAL 1021



SM G.657
A1 / A2 / A3



MM 62.5/125 OM1
Blue RAL 5015



MM 50/125 OM2
Orange RAL 2003



MM 50/125 OM3
Aqua RAL 6027



MM 50/125 OM4
Violet

Stripping

Version	Fiber qty	Stripping	Stripping - length in one piece [cm]
1F	1	TB00 / TB05 / TB10	3-5 / 20-40 / 100-150
1F	1		

Color codes

D-DATACOM (ACCORDING TO DIN VDE 0888 & IEC 60304) - Fibers & Buffers

1-12	1	2	3	4	5	6	7	8	9	10	11	12
Fiber	Red	Green	Blue	Yellow	White	Grey	Brown	Violet	Aqua	Black	Orange	Pink
Buffer	Red	Green	Blue	Yellow	White	Grey	Brown	Violet	Aqua	Black	Orange	Pink
Color 250/600/900 μm	red	green	blue	yellow	white	grey	brown	violet	aqua	black	orange	pink

Features

- Buffer made of LSOH with low coefficient of friction
- 250 μm fiber
- Variants with different stripability

Operating temperature

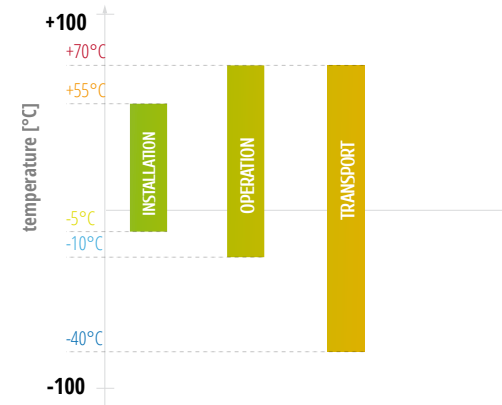

DATACOM SIMPLEX SMX CABLE

Simplex SMX 1.2 - 2.8 mm



Cable structure

1. LSOH outer jacket
2. Aramid yarns
3. Central tight buffer tube 600/900 μm with colored fiber 250 μm

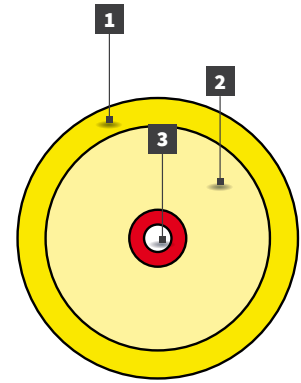

Flexible



Easy to terminate



Semi-tight



Easy-strip



Bendsafe



TRUE COLORS

Configuration

SMX				
Version	Fiber qty	Ø nominal ± 5% [mm]	Max. installation tension (ε=0.5 %) [N]	Crush [N/10 cm]
1F	1	1.2	50	200
1F	1	1.6	100	300
1F	1	1.8	150	400
1F	1	2.0	200	500
1F	1	2.8	300	800

Applications

- Distribution systems cable
- For patchcords and pigtails
- Terminals connection

Features

- LSOH with low coefficient of friction
- Aramid yarns
- Central tight buffer tube 600/900 μm
- 250 μm colored fiber

Jacket colors

Standard

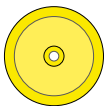

Yellow RAL 1021

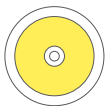

White RAL 9010



Blue RAL 5015

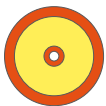

Orange RAL 2003

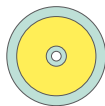

Aqua RAL 6027



Violet
RGB 196, 97, 140

Color codes

D-DATACOM (ACCORDING TO DIN VDE 0888 & IEC 60304) - Fibers & Buffers

1-12	1	2	3	4	5	6	7	8	9	10	11	12
Fiber	red	green	blue	yellow	white	grey	brown	violet	aqua	black	orange	pink
Buffer	red	green	blue	yellow	white	grey	brown	violet	aqua	black	orange	pink
Color 250/600/900 μm	red	green	blue	yellow	white	grey	brown	violet	aqua	black	orange	pink

Low-radius bending resistance SM

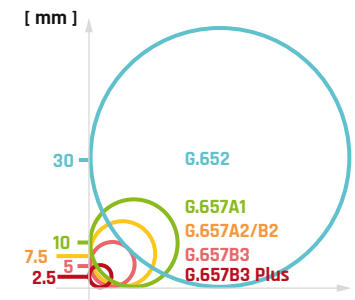

Operating temperature

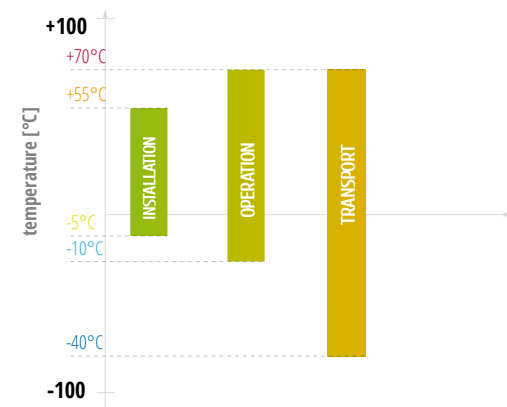



DATA COM CABLES



Selection of tubes and cables colors

Other colors available on demand



orange



green



grey



brown



red



violet



yellow



pink



black



aqua

DATACOM DC-PRIM-14



Cable structure

1. LSOH outer jacket
2. Aramid yarns
3. 250 µm optical fibers



LSOH



Bendsafe



Easy to terminate



Datacenter



TRUE COLORS

Configuration

DC-PRIM-14	
No. of fibers	1-2
Outer diameter [mm] (±5%)	1.4
Max tensile load (ε=0.5%) [N]	100
Perm tensile load [N]	50
Weight [kg/km] (±10%)	2
Min bending radius [mm]	20
Crush [N/10 cm]	50 (reversible)

Outer jacket color options:

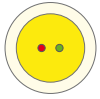

Ivory
RAL 1015



Yellow
RAL 1021



White
RAL 9010



Blue
RAL 5015



Orange
RAL 2003



Green
RAL 6018



Aqua
RAL 6027



Violet
RGB 196, 97, 140

Available colors

D-DATACOM (ACCORDING TO DIN VDE 0888 & IEC 60304) - Fibers

1-12	1	2	3	4	5	6	7	8	9	10	11	12
Fiber												
Color	red	green	blue	yellow	white	grey	brown	violet	aqua	black	orange	pink

DC-PRIM-14

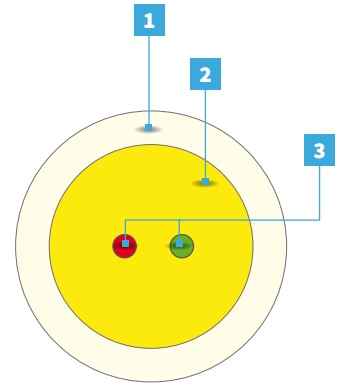

Applications

- Optical cable with aramid yarns reinforcement
- Customer connection, fully dielectric cable
- MTP/MPO termination cable
- LAN and FTTX networks
- Distribution network
- Inside house OLT connection
- Data Center connections cable

Features

- Aramid strength element
- 250 µm optical fibers (12-24)
- LSOH outer jacket

Operating temperature

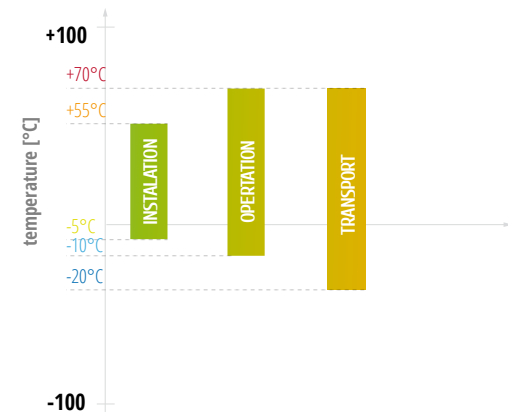



Cable structure

1. LSOH outer jacket
2. High modulus aramid strength yarns
3. 250 µm optical fibers

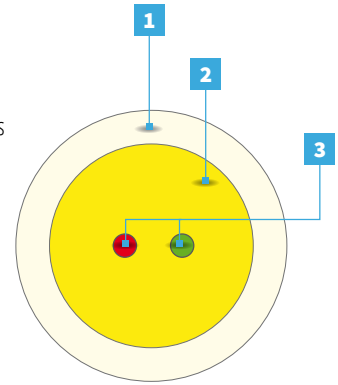

LSOH



Bendsafe



Easy to terminate



Datacenter



TRUE COLORS

Configuration

DC-PRIM-20	
No. of fibers	1-2
Outer diameter [mm] (±5%)	2.0
Max tensile load (ε=0.5%) [N]	170
Perm tensile load [N]	75
Weight [kg/km] (±10%)	3
Min bending radius [mm]	30
Crush [N/10 cm]	100 (reversible)

Outer jacket color options:

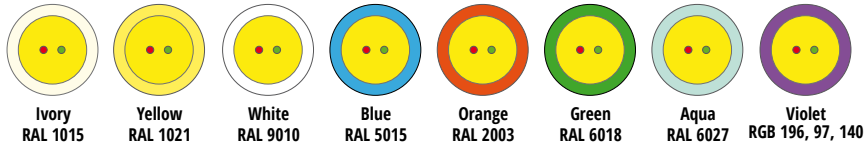

Available colors

D-DATACOM (ACCORDING TO DIN VDE 0888 & IEC 60304) - Fibers

1-12	1	2	3	4	5	6	7	8	9	10	11	12
Fiber	red	green	blue	yellow	white	grey	brown	violet	aqua	black	orange	pink
Color	red	green	blue	yellow	white	grey	brown	violet	aqua	black	orange	pink

Applications

- Optical cable with aramid yarns reinforcement
- For customer connection, fully dielectric cable
- MTP/MPO termination cable
- LAN and FTTX networks
- Distribution network,
- Inside house OLT connection
- Data center connections cable

Features

- Aramid yarns as strain relief
- 250µm optical fibers (1-2 pcs)
- Outer jacket (LSOH)
- Available in different outer jacket colors
- Available for G.657A1, G.657A2, OM3, OM4 fiber types

Operating temperature

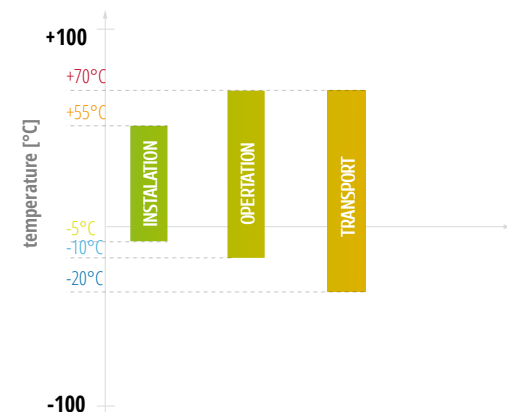

DATACOM DC-PRIM



Cable structure

1. LSOH outer jacket
2. Aramid yarns
3. 250 µm optical fibers



LSOH



Bendsafe



Easy to terminate



Datacenter



TRUE COLORS

Configuration

DC-PRIM		
No. of fibers	12	24
Outer diameter [mm] (±5%)	3.0	3.5
Max tensile load (ε=0.5%) [N]	350	350
Weight [kg/km] (±10%)	8	9
Crush [N/10 cm]	350	
Min. bend radius [mm]	45 (depends on fiber type)	60 (depends on fiber type)

Outer jacket color options:

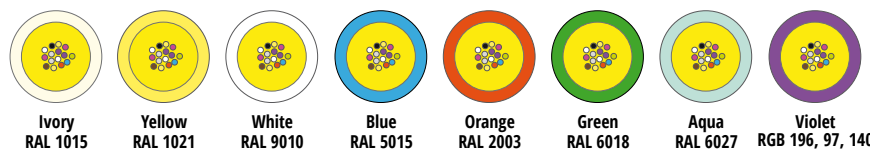

Available colors

D-DATACOM (ACCORDING TO DIN VDE 0888 & IEC 60304) - Fibers

1-12	1	2	3	4	5	6	7	8	9	10	11	12
Fiber												
Color	red	green	blue	yellow	white	grey	brown	violet	aqua	black	orange	pink
13-24	13	14	15	16	17	18	19	20	21	22	23	24
Fiber												
Code												
Color*	red	green	blue	yellow	white	grey	brown	violet	brown	natural	orange	pink

*Fiber with black mark to identify fibers 13-24

DC-PRIM

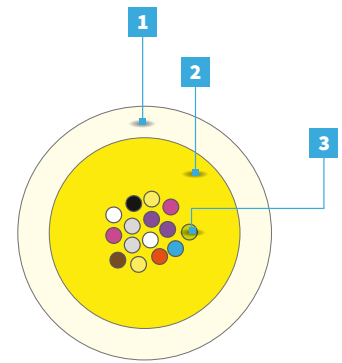

Applications

- Optical cable with aramid yarns reinforcement
- Customer connection, fully dielectric cable
- MTP/MPO termination cable
- LAN and FTTX networks
- Distribution network
- Inside house OLT connection
- Data Center connections cable

Features

- Aramid strength element
- 250 µm optical fibers (12-24)
- LSOH outer jacket

Operating temperature

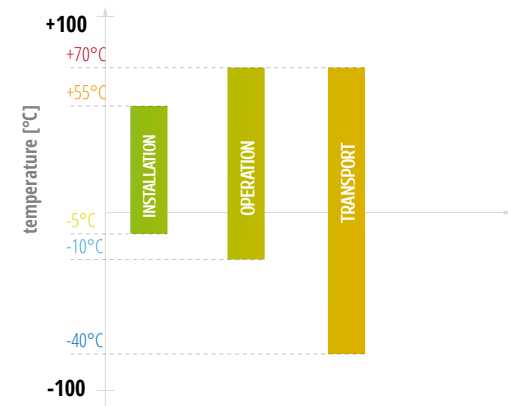

DATACOM DC-DRIM

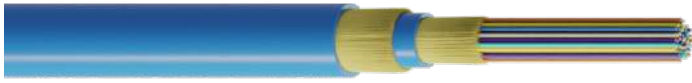

LS0H



Bendsafe



Easy to terminate



Datacenter



TRUE COLORS

Cable structure

1. LS0H outer jacket
2. Aramid yarns
3. LS0H inner jacket
4. Aramid yarns
5. 250 µm optical fibers

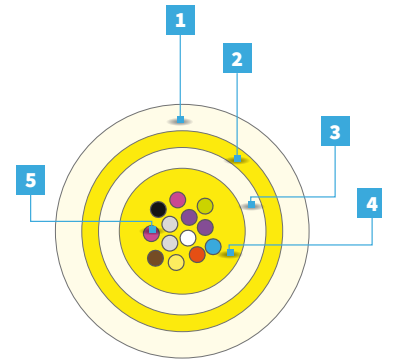

Configuration

DC-DRIM		
No. of fibers	12	24
Outer diameter [mm] (±5%)	4.5	5.0
Max tensile load (ε=0.5%) [N]	600	600
Weight [kg/km] (±10%)	8	9
Crush [N/10cm]	300	
Min. bend radius [mm]	65 (depends on fiber type)	75 (depends on fiber type)

Outer jacket color options:

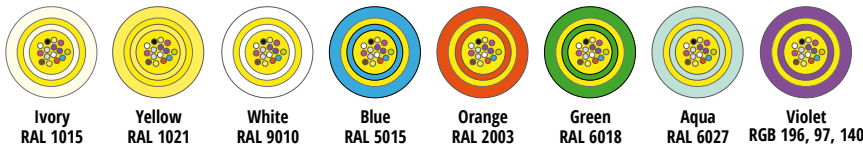

Available colors

D-DATACOM (ACCORDING TO DIN VDE 0888 & IEC 60304) - Fibers

1-12	1	2	3	4	5	6	7	8	9	10	11	12
Fiber												
Color	red	green	blue	yellow	white	grey	brown	violet	aqua	black	orange	pink
13-24	13	14	15	16	17	18	19	20	21	22	23	24
Fiber												
Code												
Color*	red	green	blue	yellow	white	grey	brown	violet	brown	natural	orange	pink

*Fiber with black mark to identify fibers 13-24

DC-DRIM

Applications

- Optical cable with aramid yarns reinforcement
- Customer connection, fully dielectric cable
- MTP/MPO termination cable
- LAN and FTTX networks
- Distribution network
- Inside house OLT connection
- Data Center connections cable

Features

- Aramid strength element in two layers
- 250 µm optical fibers (12-24)
- LS0H double jacket

Operating temperature

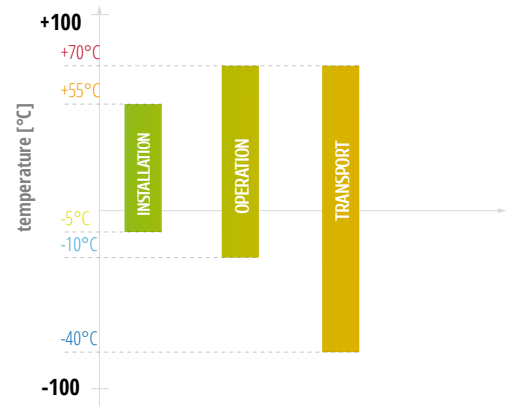

DATACOM DUPLEX ZIP CABLES

Duplex Zip Cables 1.6 - 2.8 mm



Cable structure

1. LSOH outer jacket
2. Aramid yarns
3. Central tight buffer Tube 600/900 µm with colored fibers 250 µm

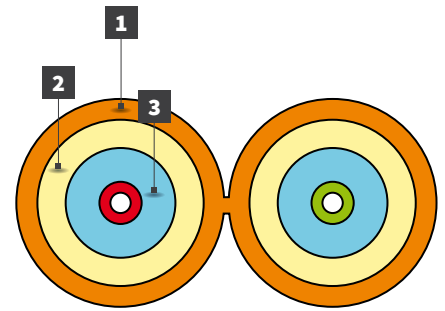

LSOH



Bendsafe



Easy to terminate



Easy-strip



Semi-tight



TRUE COLORS

Configuration

ZIP				
Version	Fiber qty	Dimensions nominal ± 5% [mm]	Max. installation tension (ε=0.5 %) [N]	Crush [N/10 cm]
2F	2	1.6 x 3.3	200	500
2F	2	1.8 x 3.7	300	500
2F	2	2.0 x 4.1	400	500
2F	2	2.8 x 5.7	600	1000

Jacket colors

Standard

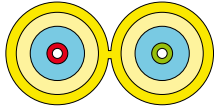

SM G.652D
Yellow RAL 1021

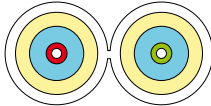

SM G.657
A1 / A2 / A3
White RAL 9010

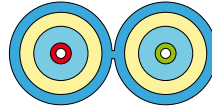

MM 62,5/125 OM1
Blue RAL 5015

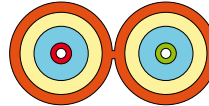

MM 50/125 OM2
Orange RAL 2003

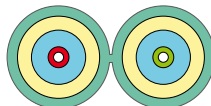

MM 50/125 OM3
Aqua RAL 6027

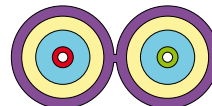

MM 50/125 OM4
Violet
RGB 196, 97, 140

Applications

- Distribution systems cable
- Patchcords and pigtails
- Terminals connection

Structure and composition

- LSOH with low coefficient of friction
- Aramid yarns
- 250 µm colored fibers

SM low-radius bending resistance

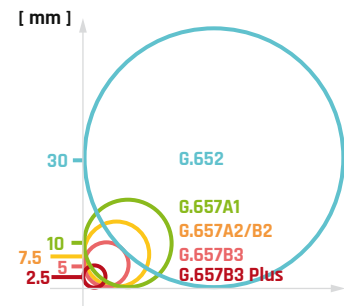

Operating temperature

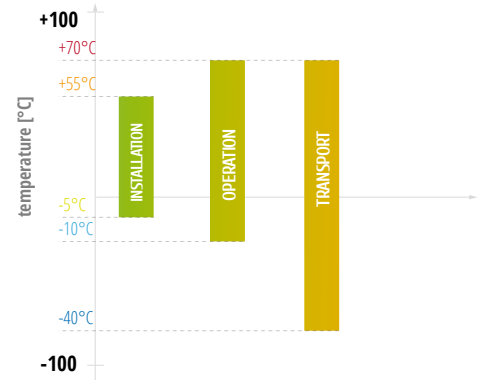

DATAKOM DC-T40

DC-T40



Cable structure

1. FRLSOH outer jacket
2. Fibreglass yarns
3. Colored fibers 250 µm

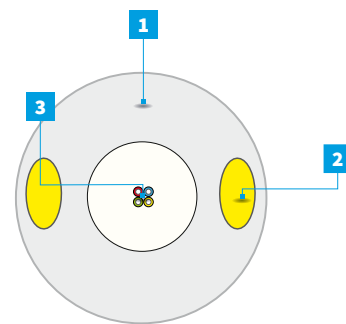

LSOH



Bendsafe



Easy to terminate



Datacenter



TRUE COLORS

Configuration

DC-T40								
Version	Fibers	Fibers per module	Total elements	Ø ± 5% [mm]	Nominal weight ±5% [kg/km]	Max. tensile load [N]		Crush [N/10 cm]
						allowed	static	
1-4F	1-4	1-4	1	4.2	17	150	50	1100

Applications

- Drop cable for FTTH networks
- Optical access cable with glass yarns reinforcement
- Fully dielectric cable
- Last mile connection

Available colors

D-DATACOM (ACCORDING TO DIN VDE 0888 & IEC 60304) - Fibers

1-12	1	2	3	4	5	6	7	8	9	10	11	12
Code												
Color	red	green	blue	yellow	white	grey	brown	violet	aqua	black	orange	pink
13-24	13	14	15	16	17	18	19	20	21	22	23	24
Fiber												
Code												
Color*	red	green	blue	yellow	white	grey	brown	violet	brown	natural	orange	pink

*Fiber with black mark to identify fibers 13-24

Features

- Fibreglass yarn as stain relief elements
- Optical fiber
- Flame retardant LSOH outer sheath

Operating temperature

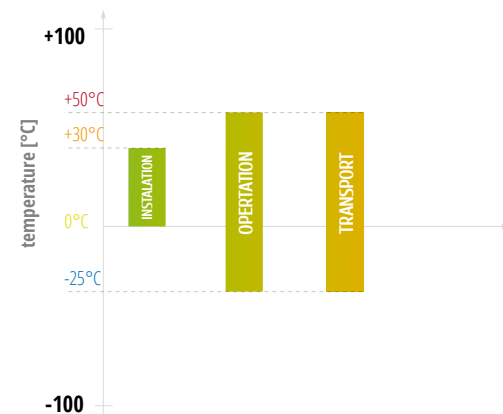

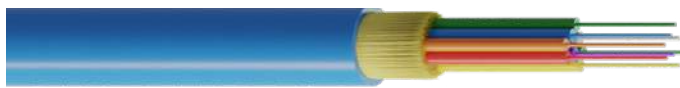

Cable structure

1. Outer jacket LS0H UV stabilized
2. Tight tubes 900 μm (LS0H) with colored fibers 250 μm
3. Aramid yarns

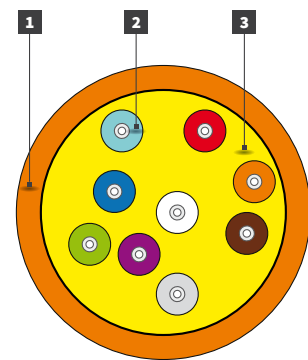

LS0H



Bendsafe



Easy to terminate



Easy-strip



Semi-tight



Datacenter



TRUE COLORS

Configuration

Version	Tight buffers [pcs]	Ø ± 5% [mm]	Nominal weight LS0H ± 5% [kg/km]	Max. tensile load [N]		Crush [N/10 cm]
				LDC		
				installation	operation	
2F	2	4.5	21	500	125	500
4F	4	5.0	26			
6F	6	5.5	30			
8F	8	5.5	35			
10F	10	6.5	40	700	175	500
12F	12	6.5	45			
16F	16	7.0	50			
24F	24	8.0	65	1000	250	

Other fiber counts available on demand

Jacket colors

D-DATACOM (ACCORDING TO DIN VDE 0888 & IEC 60304) - Fibers & Buffers

1-12	1	2	3	4	5	6	7	8	9	10	11	12
Fiber	■	■	■	■	■	■	■	■	■	■	■	■
Buffer	■	■	■	■	■	■	■	■	■	■	■	■
Color 250/600/900 μm	red	green	blue	yellow	white	grey	brown	violet	aqua	black	orange	pink
13-24	13	14	15	16	17	18	19	20	21	22	23	24
Fiber	■	■	■	■	■	■	■	■	■	■	■	■
Code	■	■	■	■	■	■	■	■	■	■	■	■
Color 250 μm	red	green	blue	yellow	white	grey	brown	violet	aqua	natural	orange	pink
Color* 600/900 μm	red	green	blue	yellow	white	grey	brown	violet	brown	dark green	orange	pink

*Buffer with black mark to identify fibers 13-24

Applications

- Indoor/outdoor installations
- Distribution networks in multifamily buildings
- FTTH Connections
- Distribution systems
- Fully dielectric
- LAN and FTTH network
- ODF connection
- Datacenter distribution

Features

- Compact design
- Lightweight
- Flexible
- Easy to strip
- Fully dielectric
- Reduced diameter
- Direct connectorization

Operating temperature

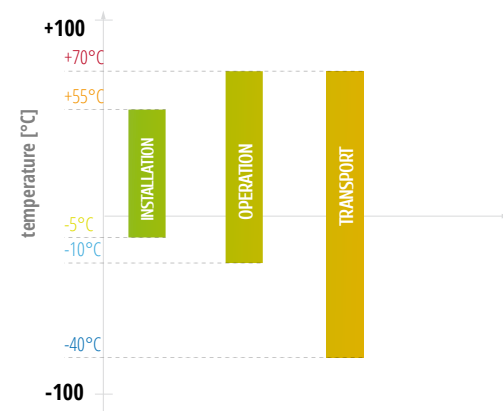



Cable structure

1. Outer jacket LSOH UV stabilized
2. Subcables 1.8 mm with tight tubes 900 μm (LSOH) with 250 μm colored fibers
3. Aramid yarns
4. Central FRP strength member
5. Ripcord

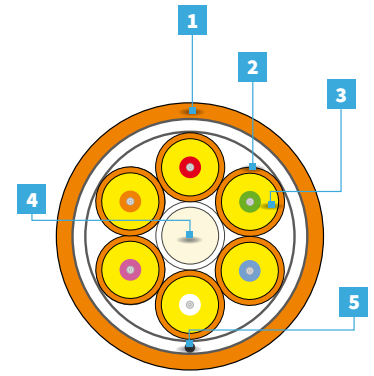

LSOH



Bendsafe



Easy to terminate



Easy-strip



Semi-tight



Datacenter



TRUE COLORS

Configuration

Version	Fiber qty	Ø ± 5% [mm]	Nominal weight LSOH ± 5% [kg/km]	Max. tensile load [N]		Crush [N/10 cm]
				LBR		
				installation	operation	
4F	4	6.5	48	750	250	2000
6F	6	7.5	63	1200	400	
8F	8	8.7	85	1500	500	
12F	12	10.9	131	1500	500	
16F	16	11.3	119	1700	550	
18F	18	11.3	131	1700	550	
24F	24	13.0	179	2000	660	

Applications

- Indoor/outdoor installations
- Distribution networks in multifamily buildings
- FTTH Connections
- Distribution systems
- Fully dielectric
- LAN and FTTH network
- ODF connection
- Datacenter distribution

Features

- Simplex sub cable up to 24 fibers
- Fully dielectric cable
- Aramid yarns as tensile elements
- UV Resistant and LSOH flame retardant outer jacket

Standard jacket colors:

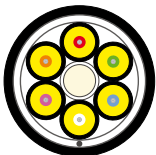

PE Black RAL9005

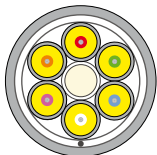

LSOH Grey RAL7022

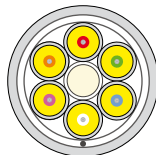

LSOH Light Grey RAL7037

Outer jacket color options:

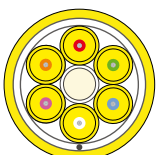

SM G.652D RAL 1021

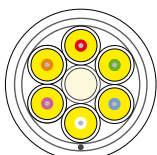

SM G657A1, A2, A3 RAL 9010

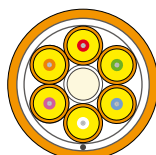

MM 50/125 OM2 RAL 2003

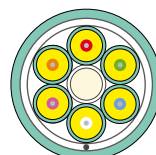

MM 50/125 OM3 RAL6027

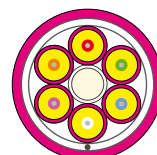

MM 50/125 OM4 RAL4003

Operating temperature

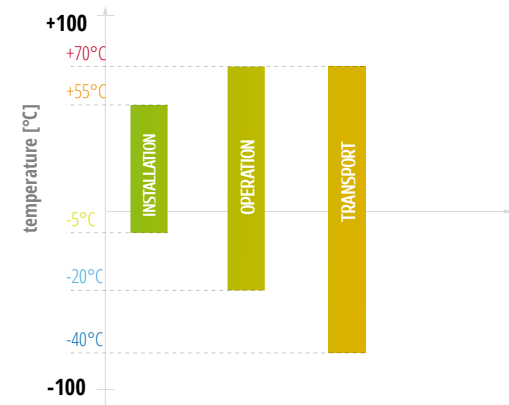

DATACOM EXO-FU CABLES

EXO-FU Cables *Loose tube*



Cable structure

1. LSOH sheath
2. Glass yarns
3. Loose tube (PBT)
4. Optical fibers
5. Thixotropic filling compound
6. Ripcord

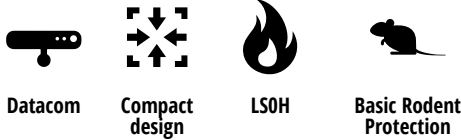
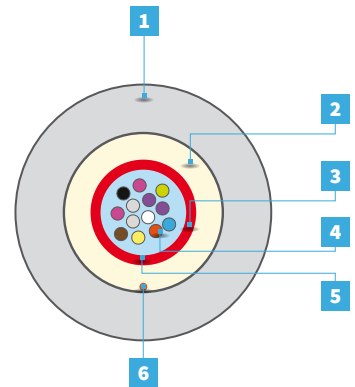

Configuration

EXO-FU						
Version	Fiber qty	Ø ± 5% [mm]	Nominal weight LSOH ± 5% [kg/km]	Max. tensile load [N]		Crush [N/10 cm]
				installation	operation	
1T x 2-12F	2-12	6.8	48	1100 (ε=0.4%)	550 (ε=0.25%)	1600
1T x 14-24F	14-24	6.8	49			

Available colors

D-DATACOM (ACCORDING TO DIN VDE 0888 & IEC 60304) - Fibers

1-12	1	2	3	4	5	6	7	8	9	10	11	12
Code												
Color	red	green	blue	yellow	white	grey	brown	violet	aqua	black	orange	pink
13-24	13	14	15	16	17	18	19	20	21	22	23	24
Fiber												
Code												
Color*	red	green	blue	yellow	white	grey	brown	violet	brown	natural	orange	pink

*Fiber with black mark to identify fibers 13-24

Jacket colors

Standard



Optional

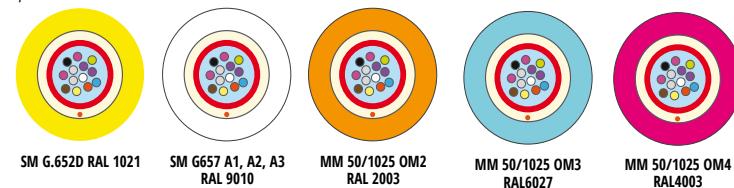

Fiber identification

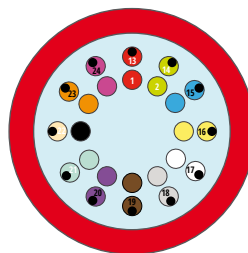

Operating temperature

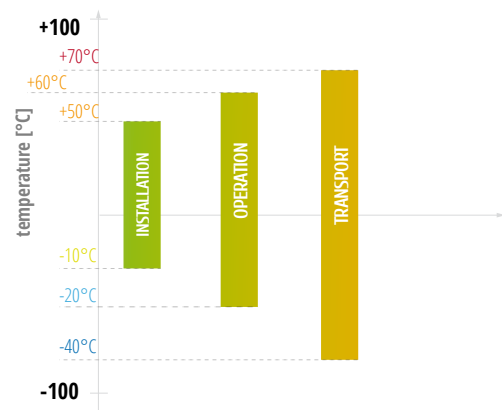

DATACOM EXO-FI CABLES

EXO-FI Cables *Loose tube*



Cable structure

1. LSOH sheath
2. Glass yarns
3. Loose tube (PBT)
4. Optical fibers
5. Thixotropic filling compound
6. Ripcord

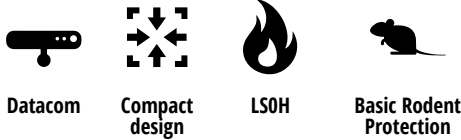
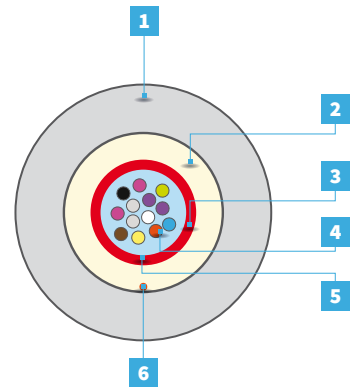

Configuration

EXO-FU						
Version	Fiber qty	Ø ± 5% [mm]	Nominal weight LSOH ± 5% [kg/km]	Max. tensile load [N]		Crush [N/10 cm]
				installation	operation	
1T x 2-12F	2-12	7.1	54	2000 (ε=0.4%)	1000 (ε=0.25%)	1600
1T x 14-24F	14-24	7.1	55			

Applications

- Fully dielectric cable
- Basic rodent protection
- LAN and FTTH networks
- Distribution network
- ODF connections

Available colors

D-DATACOM (ACCORDING TO DIN VDE 0888 & IEC 60304) - Fibers

1-12	1	2	3	4	5	6	7	8	9	10	11	12
Code	■	■	■	■	■	■	■	■	■	■	■	■
Color	red	green	blue	yellow	white	grey	brown	violet	aqua	black	orange	pink
13-24	13	14	15	16	17	18	19	20	21	22	23	24
Code	■	■	■	■	■	■	■	■	■	■	■	■
Color	red	green	blue	yellow	white	grey	brown	violet	aqua	natural	orange	pink

Features

- Central loose tubes (PBT Ø 3.0mm) with thixotropic filling compound
- Glass yarns as strain relief and water absorbent
- Polyester ripcord
- UV stabilized LSOH sheath (different colors available)

*In 24-fiber tube construction colors will be repeated to facilitate identification, fibers 13-24 will have rings every 25 cm

Jacket colors

Standard



Optional

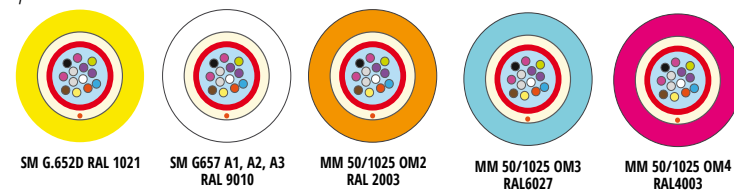

Fiber identification

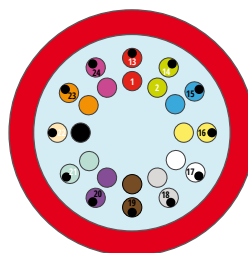

Operating temperature

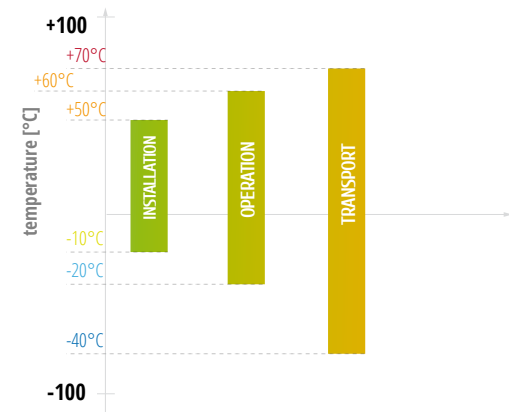

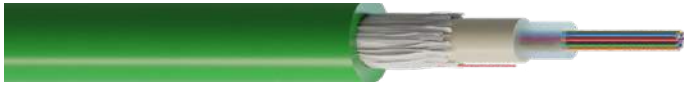

Cable structure

1. LSOH outer jacket
2. Central loose tube (PBT) with colored fibers in filling compound
3. Optical fibers
4. Fiberglass yarns
5. Ripcord

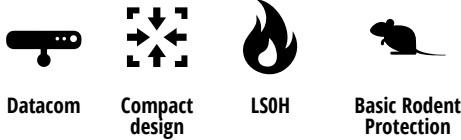
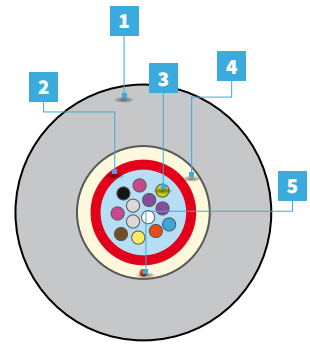

Configuration

EXO-GU							
Version	Fiber qty	Fibers per tube	Ø ± 5% [mm]	Nominal weight LSOH ± 5% [kg/km]	Max. tensile load [N]		Crush [N/10 cm]
					installation	operation	
1T x 2F	2	2	5.8	34	1200 (ε=0,33%)	400	1500
1T x 4F	4	4	5.8	34			
1T x 6F	6	6	5.8	35			
1T x 8F	8	8	5.8	35			
1T x 12F	12	12	5.8	35			
1T x 16F	16	16	5.8	35			
1T x 18F	18	18	5.8	36			
1T x 24F	24	24	5.8	36			

Applications

- Fully dielectric cable
- Basic rodent protection
- LAN and FTTH networks
- Distribution network
- ODF connections

Features

- Central loose tube (PBT) with filling compound
- Optical fibers
- Fiberglass as water absorbent and strain relief element
- LSOH outer jacket

Available colors

D-DATACOM (ACCORDING TO DIN VDE 0888 & IEC 60304) - Fibers

1-12	1	2	3	4	5	6	7	8	9	10	11	12
Code	■	■	■	■	■	■	■	■	■	■	■	■
Color	red	green	blue	yellow	white	grey	brown	violet	aqua	black	orange	pink
13-24	13	14	15	16	17	18	19	20	21	22	23	24
Code	■	■	■	■	■	■	■	■	■	■	■	■
Color	red	green	blue	yellow	white	grey	brown	violet	aqua	natural	orange	pink

*In 24-fiber tube construction colors will be repeated to facilitate identification, fibers 13-24 will have rings every 25 cm;

Jacket colors

Standard



Optional

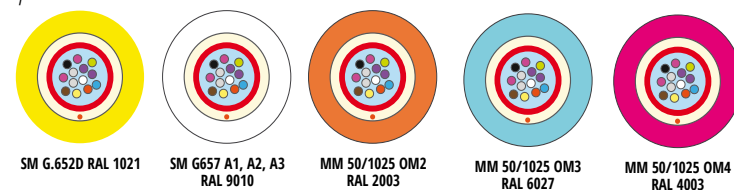

Fiber identification

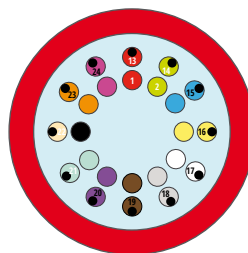

Operating temperature

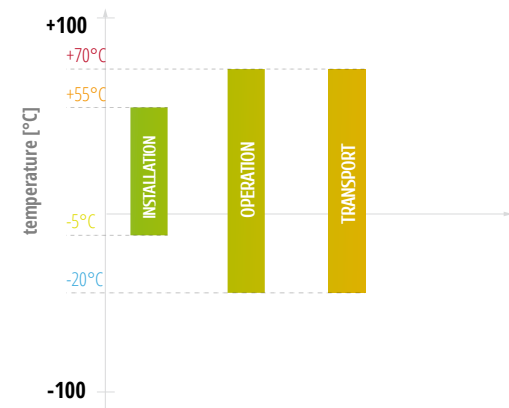

DATACOM EXO-GO CABLES

EXO-GO Cables *Loose*



Cable structure

1. LSOH outer jacket
2. Central loose tube (PBT) with colored fibers in filling compound
3. Optical fibers
4. Fiberglass yarns
5. Ripcord

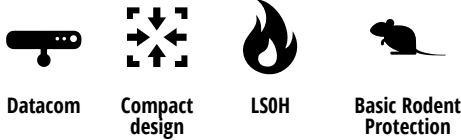
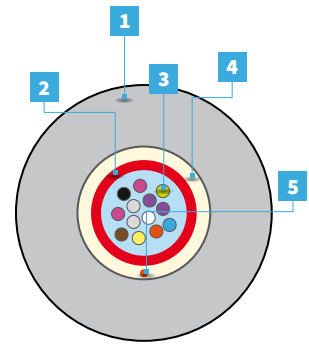

Configuration

EXO-GO							
Version	Fiber qty	Fibers per tube	Ø ± 5% [mm]	Nominal weight LSOH ± 5% [kg/km]	Max. tensile load [N]		Crush [N/10 cm]
					installation	operation	
1T x 2F	2	2	5.9	37	1500 (ε=0,33%)	500	1500
1T x 4F	4	4	5.9	37			
1T x 6F	6	6	5.9	37			
1T x 8F	8	8	5.9	37			
1T x 12F	12	12	5.9	38			
1T x 16F	16	16	5.9	38			
1T x 18F	18	18	5.9	38			
1T x 24F	24	24	5.9	40			

Applications

- Fully dielectric cable
- Basic rodent protection
- LAN and FTTH networks
- Distribution network
- ODF connections

Features

- Central loose tube (PBT) with filling compound
- Optical fibers
- Fiberglass as water absorbent and strain relief element
- LSOH outer jacket

Available colors

D-DATACOM (ACCORDING TO DIN VDE 0888 & IEC 60304) - Fibers

1-12	1	2	3	4	5	6	7	8	9	10	11	12
Code	■	■	■	■	■	■	■	■	■	■	■	■
Color	red	green	blue	yellow	white	grey	brown	violet	aqua	black	orange	pink
13-24	13	14	15	16	17	18	19	20	21	22	23	24
Code	■	■	■	■	■	■	■	■	■	■	■	■
Color	red	green	blue	yellow	white	grey	brown	violet	aqua	natural	orange	pink

*In 24-fiber tube construction colors will be repeated to facilitate identification, fibers 13-24 will have rings every 25 cm;

Jacket colors

Standard



Optional

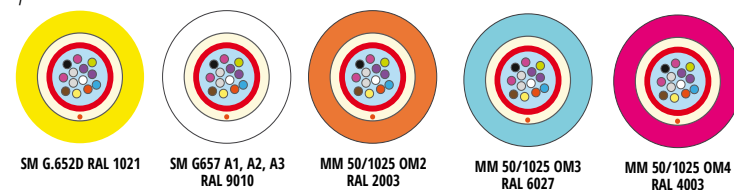

Fiber identification

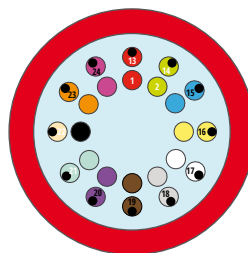

Operating temperature

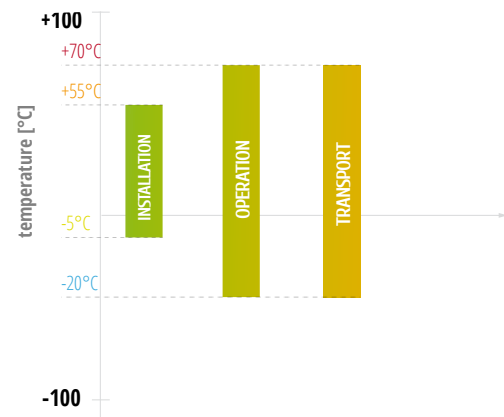



Cable structure

1. LSOH outer jacket
2. Central loose tube (PBT) with colored fibers in filling compound
3. Optical fibers
4. Fiberglass yarns
5. Ripcord

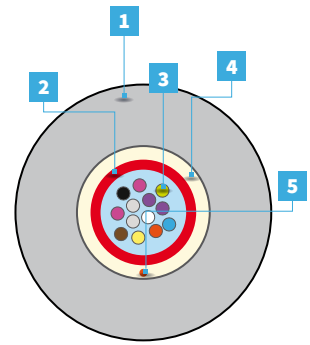

Datacom



Compact design



LSOH



Basic Rodent Protection

Configuration

EXO-GI							
Version	Fiber qty	Fibers per tube	Ø ± 5% [mm]	Nominal weight LSOH ± 5% [kg/km]	Max. tensile load [N]		Crush [N/10 cm]
					installation	operation	
1T x 2F	2	2	6.1	38	1800 (ε=0,33%)	600	1500
1T x 4F	4	4	6.1	38			
1T x 6F	6	6	6.1	39			
1T x 8F	8	8	6.1	40			
1T x 12F	12	12	6.1	40			
1T x 16F	16	16	6.1	41			
1T x 18F	18	18	6.1	42			
1T x 24F	24	24	6.1	42			

Applications

- Fully dielectric cable
- Basic rodent protection
- LAN and FTTH networks
- Distribution network
- ODF connections

Features

- Central loose tube (PBT) with filling compound
- Optical fibers
- Fiberglass as water absorbent and strain relief element
- LSOH outer jacket

Available colors

D-DATACOM (ACCORDING TO DIN VDE 0888 & IEC 60304) - Fibers

1-12	1	2	3	4	5	6	7	8	9	10	11	12
Code	■	■	■	■	■	■	■	■	■	■	■	■
Color	red	green	blue	yellow	white	grey	brown	violet	aqua	black	orange	pink
13-24	13	14	15	16	17	18	19	20	21	22	23	24
Code	■	■	■	■	■	■	■	■	■	■	■	■
Color	red	green	blue	yellow	white	grey	brown	violet	aqua	natural	orange	pink

*In 24-fiber tube construction colors will be repeated to facilitate identification, fibers 13-24 will have rings every 25 cm;

Jacket colors

Standard



PE Black RAL9005



LSOH Grey RAL7022

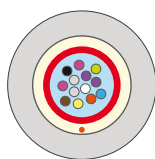

LSOH Light RAL7037

Fiber identification

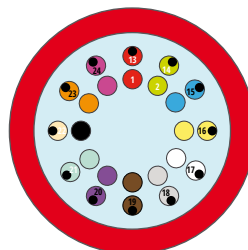

Operating temperature

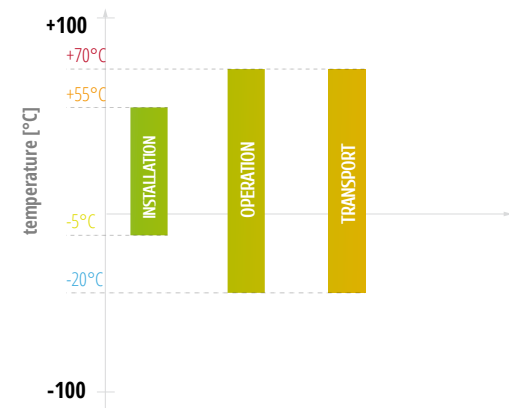

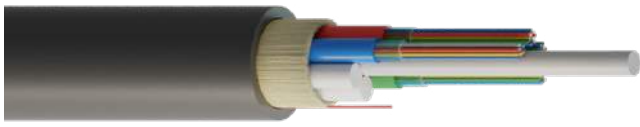

Cable structure

1. LSOH outer jacket
2. Water-blocking fiberglass yarns
3. Water blocking yarns
4. PET tape
5. Central strength member (FRP)
6. Loose tubes (PBT) with colored fibers in filling gel
7. Fillers
8. Ripcord

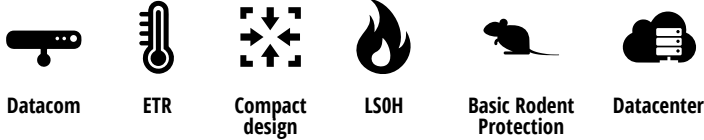
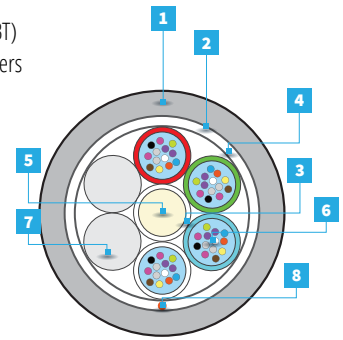

Configuration

BDC-MSA										
Version	Fibers	Fibers per tube	Total elements	Active tubes	Ø ± 5% [mm]	Nominal weight PE ±5% [kg/km]	Nominal weight LSOH ±5% [kg/km]	Max. tensile load [N]		Crush [N/10 cm]
								instal-lation	oper-ation	
1T x 12F	12	12	6	1	8.2	50	65	1500	550	1500
2T x 6F	12	6	6	2	8.2	50	65	1550	780	
2T x 12F	24	12	6	2	8.2	51	65	1500	550	
4T x 6F	24	6	6	4	8.2	51	66	1550	780	
3T x 12F	36	12	6	3	8.2	52	67	1500	550	
6T x 6F	36	6	6	6	8.2	53	68	1550	780	
4T x 12F	48	12	6	4	8.2	53	68	1500	550	
5T x 12F	60	12	6	5	8.2	54	69	1500	550	
6T x 12F	72	12	6	6	8.2	54	69	1500	550	
8T x 12F	96	12	8	8	9.3	71	86	1620	750	
12T x 12F	144	12	12	12	11.5	104	126	1620	850	

Applications

- Fully dielectric cable
- Basic rodent protection
- LAN and FTTH networks
- Distribution network
- ODF connections

Features

- FRP strength and anti-buckling element
- Optical fibers
- Loose tube with filling compound (PBT Ø 1.8 mm)
- Dry yarns to prevent moisture into the cable
- Fiberglass as water absorbent and strain relief element
- UV stabilized LSOH jacket

Available colors

D-DATACOM (ACCORDING TO DIN VDE 0888 & IEC 60304) - Fibers

1-12	1	2	3	4	5	6	7	8	9	10	11	12
Code	■	■	■	■	■	■	■	■	■	■	■	■
Color	red	green	blue	yellow	white	grey	brown	violet	aqua	black	orange	pink

D-DATACOM (ACCORDING TO DIN VDE 0888 & IEC 60304) - Tubes

Tube	1	2	3	4	5	6	7	8	9	10	11	12
Code	■	■	■	■	■	■	■	■	■	■	■	■
Color	red	green	blue	yellow	white	grey	brown	violet	aqua	black	orange	pink

*In case of lower fiber count some tubes can be replaced by fillers.

Operating temperature

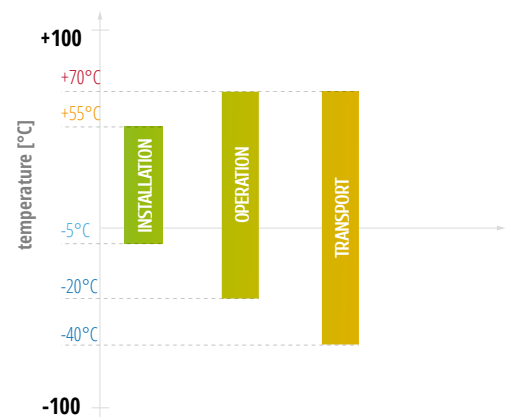



FTTH Cables

VC-D20/VC-D30 VC-D40/VC-DCY

SOLID CONNECTION TO YOUR PROVIDER



**BEND
RESISTANCE**



**LSOH
SAFE COVER**



**EASY TO
TERMINATE**



**SMALL
DIMENSIONS**



**SAFE
DAILY USE**

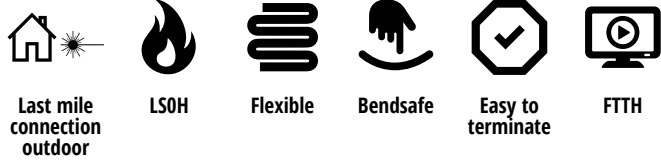

Cable structure

1. LSOH outer jacket
2. Aramid yarns
3. 900 µm central semi tight buffer tube with 250 µm colored fiber

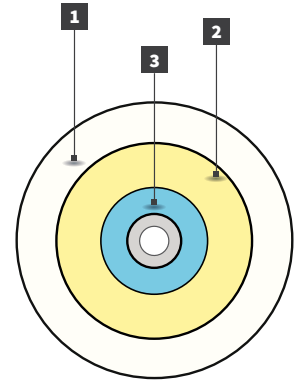

Configuration

VC-D20	
No. of fibers	1F 900 µm
Outer diam [mm]	2.0
Tensile load perm/inst. [N]	75/200
Weight [kg/km]	7
Min. bend radius [mm]	10-60 mm*
Crush [N/10 cm]	300

*Depends on fiber type

Applications

- Optical cable with aramid yarns reinforcement
- Customer connection
- Fully dielectric cable
- Last mile connection
- LAN and FTTX networks
- Distribution network
- ODF connections
- Inside house OLT connection

Bend radius/maximum attenuation

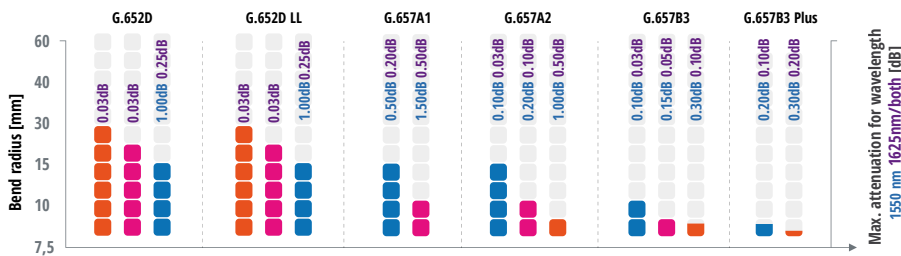

Features

- Aramid strength element
- Optical 900 µm semi tight tube
- LSOH outer jacket

Operating temperature

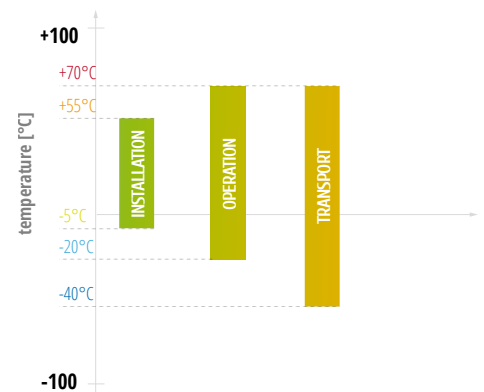

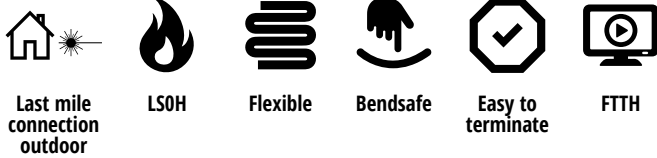

Cable structure

1. LSOH outer jacket
2. Aramid yarns
3. 900 µm central semi tight buffer tube with 250 µm colored fiber

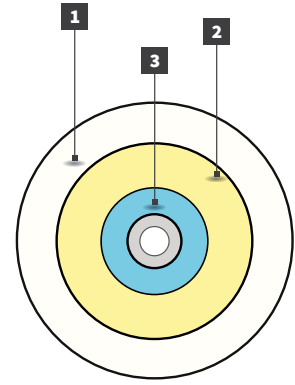

Configuration

VC-D30	
No. of fibers	1F 900 µm
Outer diam [mm]	3.0
Tensile load perm/inst. [N]	60/170
Weight [kg/km]	8
Min. bend radius [mm]	10-60 mm*
Crush [N/10 cm]	500

*Depends on fiber type

Applications

- Optical cable with aramid yarns reinforcement
- Customer connection
- Fully dielectric cable
- Last mile connection
- LAN and FTTX networks
- Distribution network
- ODF connections
- Inside house OLT connection

Bend radius/maximum attenuation

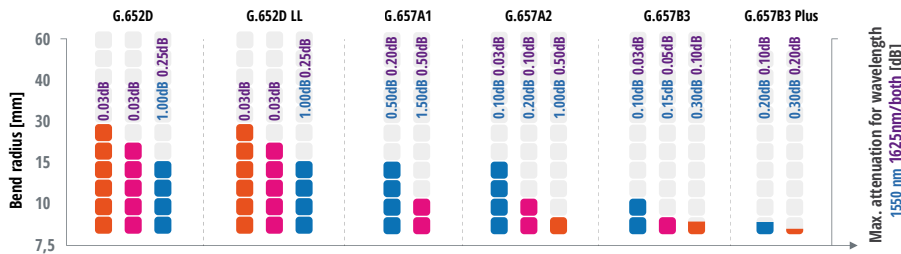

Features

- Aramid strength element
- Optical 900 µm semi tight tube
- LSOH outer jacket

Operating temperature

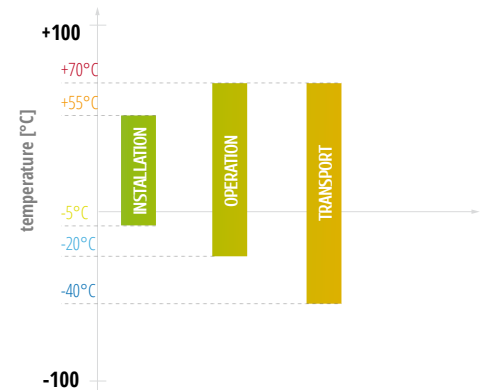

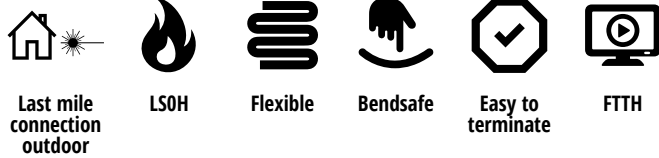

Cable structure

1. LSOH outer jacket
2. Aramid yarns
3. 900 µm central semi tight buffer tube with 250 µm colored fiber

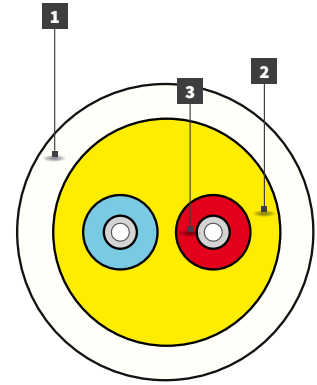

Configuration

VC-D40	
No. of fibers	1-2F 900 µm
Outer diam [mm]	4.0
Tensile load perm/inst. [N]	150/400
Weight [kg/km]	15
Min. bend radius [mm]	10-60 mm*
Crush [N/10 cm]	1000

*Depends on fiber type

Applications

- Optical cable with aramid yarns reinforcement
- Customer connection
- Fully dielectric cable
- Last mile connection
- LAN and FTTX networks
- Distribution network
- ODF connections
- Inside house OLT connection

Bend radius/maximum attenuation

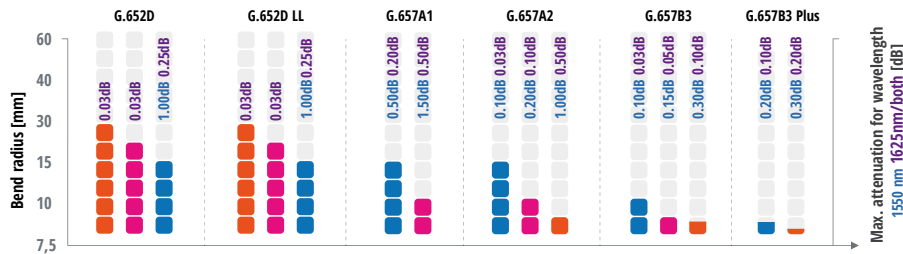

Features

- Aramid strength element
- Optical 900 µm semi tight tube
- LSOH outer jacket

Operating temperature

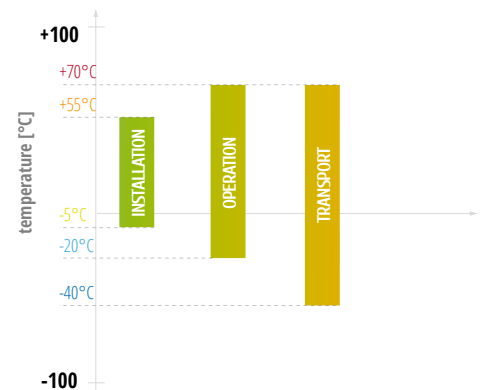



Cable structure

1. LSOH outer jacket (white/ivory/black)
2. FRP rod
3. 250 μ m optical fibers

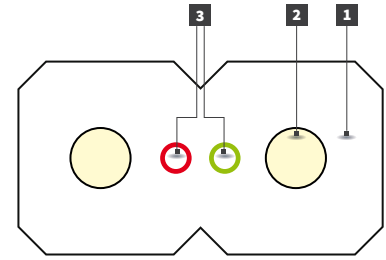

Configuration

VC-DCY	
No. of fibers	1-4F 900 μ m
Outer diam [mm]	2.0x3.1 \pm 0.2
Tensile load perm/inst. [N]	50/100
Weight [kg/km]	8.3
Min. bend radius [mm]	15-40 mm*
Crush [N/10 cm]	1000

*Depends on fiber type

Applications

- FTTH drop cable reinforced with FRP rods
- Customer connection
- Fully dielectric cable
- Last mile connection
- LAN and FTTH networks
- Distribution network
- ODF connections
- Inside house OLT connection

Bend radius/maximum attenuation

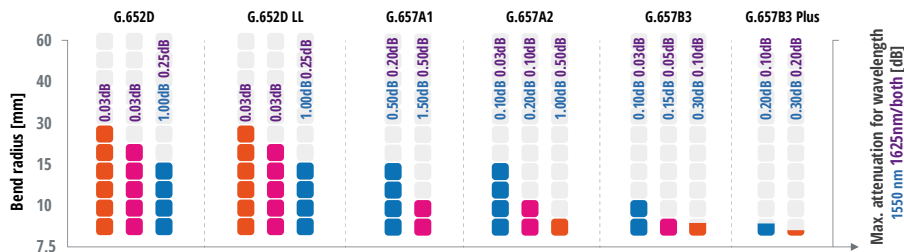

Features

- FRP rods
- 250 μ m optical fibers
- LSOH outer jacket

Operating temperature

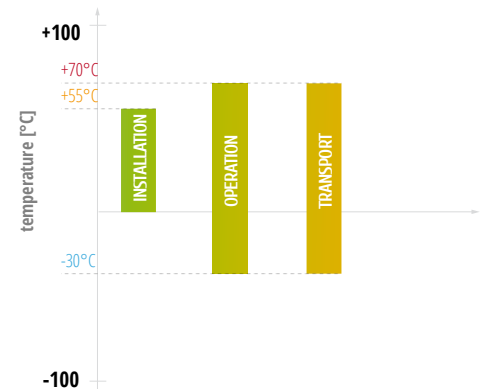



Crushproof



Bendproof



Knotproof



RESIBEND[®] CABLES

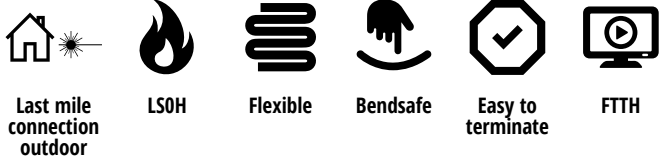

Cable structure

1. LSOH outer jacket
2. Aramid yarns
3. 900 µm central semi tight buffer tube with 250 µm colored fiber

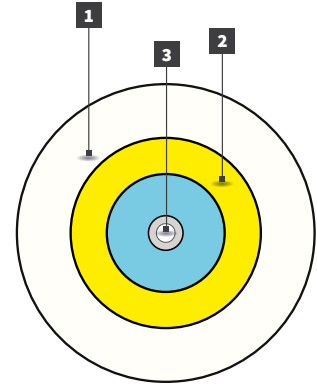

Configuration

VC-D30 RESIBEND®	
No. of fibers	1F 900 µm
Outer diam [mm]	3.0
Tensile load perm/inst. [N]	60/170
Weight [kg/km]	8
Min. bend radius [mm]	5
Crush [N/10 cm]	500

Bend radius/maximum attenuation

G.657B3		
Fiber bending radius [mm]	Max. change in attenuation [dB]	
	1550 nm	1625 nm
5	0.10	0.25
7.5	0.05	0.15
10	0.03	0.10

Applications

- Optical cable with aramid yarns reinforcement
- For customer connection
- Fully dielectric cable
- Last mile connection
- LAN and FTTH networks
- Distribution network
- ODF connections
- Inside house OLT connection

Features

- Aramid yarns as strain relief
- Optical fiber in 900 µm semi tight buffer
- LSOH outer jacket (various colors available)
- G.657B3 optical fibers

Operating temperature

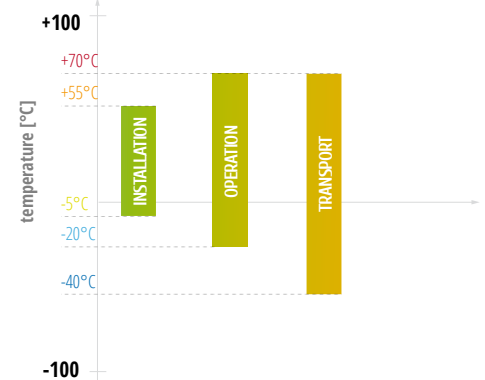

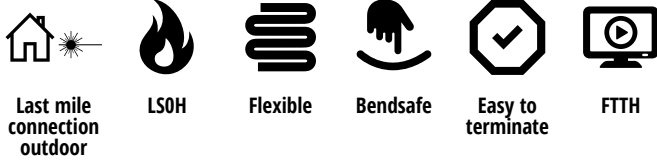

Cable structure

1. LSOH outer jacket
2. Aramid yarns
3. 900 µm central semi tight buffer tube with 250 µm colored fiber

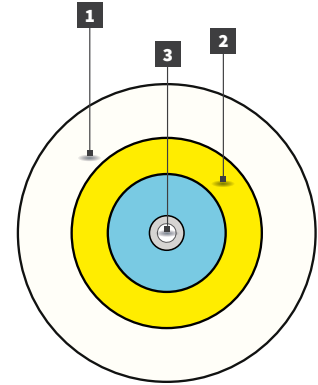

Configuration

VC-D30 RESIBEND PLUS®	
No. of fibers	1F 900 µm
Outer diam [mm]	3.0
Tensile load perm/inst. [N]	60/170
Weight [kg/km]	8
Min. bend radius [mm]	2.5
Crush [N/10 cm]	500

Bend radius/maximum attenuation

Fiber bending radius [mm]	G.657B3+	
	Max. change in attenuation [dB]	
	1550 nm	1625 nm
2.5	0.20	0.30
5	0.10	0.20

Applications

- Optical cable with aramid yarns reinforcement
- For customer connection
- Fully dielectric cable
- Last mile connection
- LAN and FTTH networks
- Distribution network
- ODF connections
- Inside house OLT connection

Features

- Aramid yarns as strain relief
- Optical fiber in 900 µm semi tight buffer
- LSOH outer jacket (various colors available)
- G.657B3+ optical fibers

Operating temperature

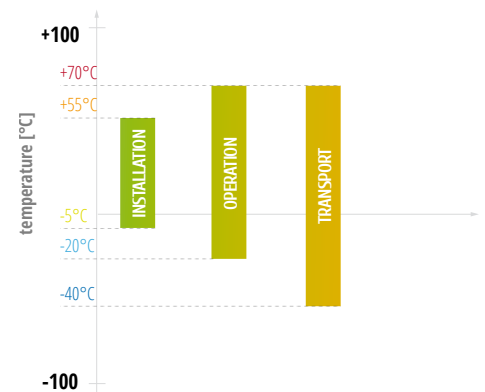



**Easy Section
Module[®]**

Easy Section Module



Easy Section Module®



Last mile connection outdoor



LSOH



Flexible



Bendsafe



Easy to terminate



FTTH

Cable structure

1. LSOH outer jacket
2. Aramid yarns
3. Optical fibers (250 μm) in Easy Section Module®

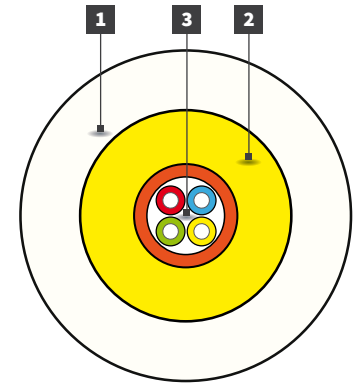

Configuration

VC-D20 EASY SECTION MODULE®									
Version	Fibers	Fibers per module	Total elements	Active modules	∅ ± 5% [mm]	Nominal weight ±5% [kg/km]	Max. tension [N]		Crush [N/10 cm]
							allowed	static	
2F	2	2	1	1	2.0	7	200	75	1000
4F	4	4	1	1	2.0	7			

Bend radius/maximum attenuation

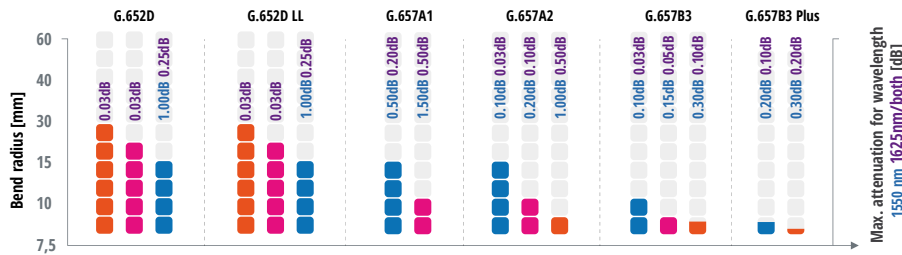

Applications

- Optical cable with aramid yarns reinforcement
- For customer connection
- Fully dielectric cable
- Last mile connection
- LAN and FTTH networks
- Distribution network
- ODF connections
- Inside house OLT connection

Features

- Aramid strength element
- Optical fibers (up to 4 pcs) inside 900 μm Easy Section Module®
- LSOH outer jacket

Operating temperature

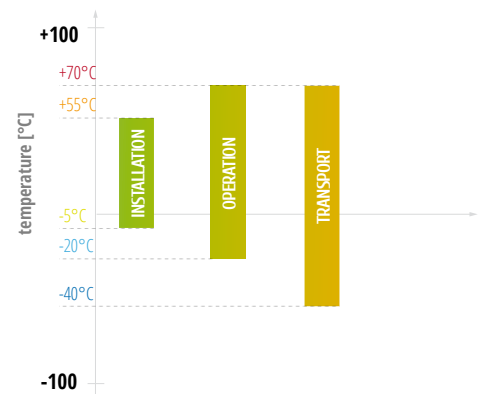



Easy Section Module®



Last mile connection outdoor



LSOH



Flexible



Bendsafe



Easy to terminate



FTTH

Cable structure

1. LSOH outer jacket
2. Aramid yarns
3. Optical fibers (250 μm) in Easy Section Module®

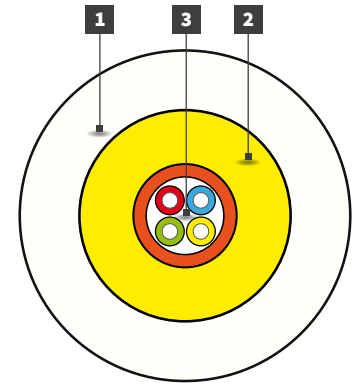

Configuration

VC-D30 EASY SECTION MODULE®									
Version	Fibers	Fibers per module	Total elements	Active modules	Ø ± 5% [mm]	Nominal weight ±5% [kg/km]	Max. tension [N]		Crush [N/10 cm]
							allowed	static	
2F	2	2	1	1	3.1	9	170	60	1000
4F	4	4	1	1	3.1	9			

Bend radius/maximum attenuation

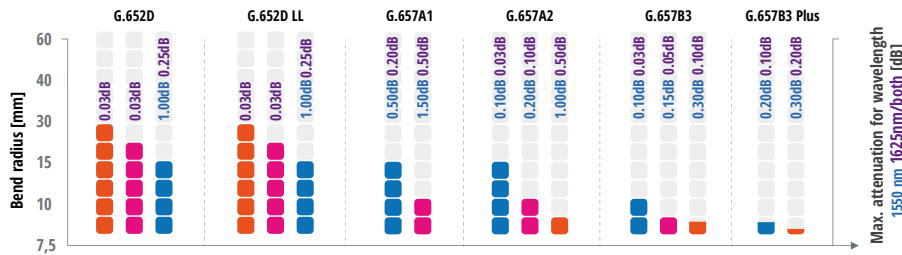

Applications

- Optical cable with aramid yarns reinforcement
- For customer connection
- Fully dielectric cable
- Last mile connection
- LAN and FTTH networks
- Distribution network
- ODF connections
- Inside house OLT connection

Features

- Aramid strength element
- Optical fibers (up to 4 pcs) inside 900 μm Easy Section Module®
- LSOH outer jacket

Operating temperature

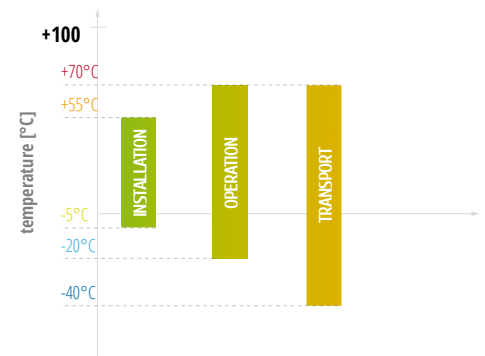



Easy Section Module®



Last mile connection outdoor



LSOH



Flexible



Bendsafe



Easy to terminate



FTTH

Cable structure

1. LSOH outer jacket
2. Aramid yarns
3. Optical fibers (250 μm) in Easy Section Module®

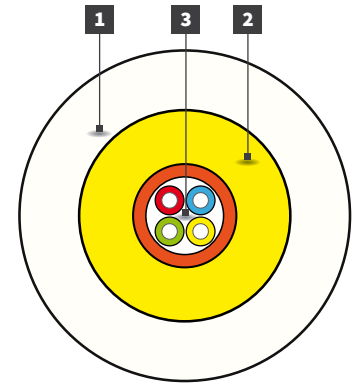

Configuration

VC-D40 EASY SECTION MODULE®									
Version	Fibers	Fibers per module	Total elements	Active modules	Ø ± 5% [mm]	Nominal weight ±5% [kg/km]	Max. tension [N]		Crush [N/10 cm]
							allowed	static	
2F	2	2	1	1	4.1	15	420	150	1000
4F	4	4	1	1	4.1	15			

Bend radius/maximum attenuation

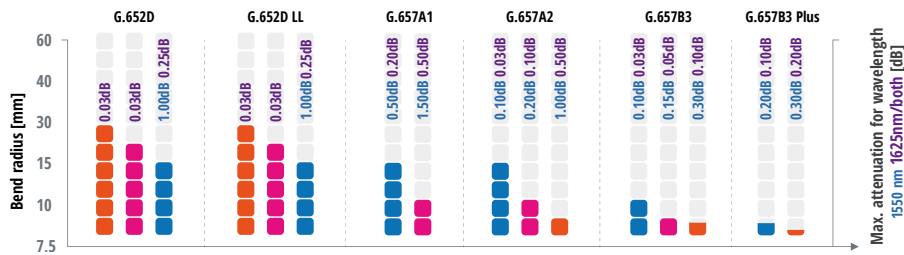

Applications

- Optical cable with aramid yarns reinforcement
- For customer connection
- Fully dielectric cable
- Last mile connection
- LAN and FTTH networks
- Distribution network
- ODF connections
- Inside house OLT connection

Features

- Aramid strength element
- Optical fibers (up to 4 pcs) inside 900 μm Easy Section Module®
- LSOH outer jacket

Operating temperature

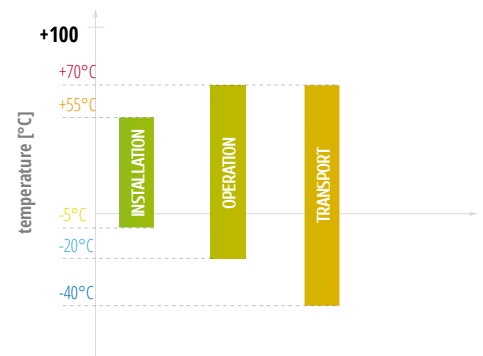



Cable structure

1. LSOH outer jacket
2. Aramid yarns
3. 250 µm optical fibers

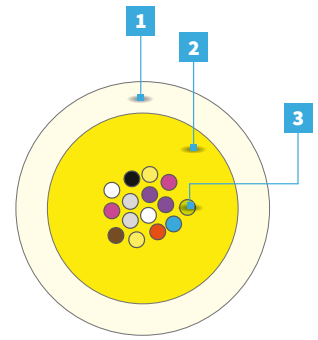

LSOH



Bendsafe



Easy to terminate



Datacenter



TRUE COLORS

Configuration

DC-PRIM		
No. of fibers	12	24
Outer diameter [mm]	3.0	3.5
Tensile load perm/inst. [N]	350/150	350/150
Weight [kg/km]	8	9
Min. bend radius [mm]	45 (depends on fiber type)	50 (depends on fiber type)
Min. bend radius [mm]	150	

Available colors

D-DATACOM (ACCORDING TO DIN VDE 0888 & IEC 60304) - Fibers

1-12	1	2	3	4	5	6	7	8	9	10	11	12
Fiber												
Color	red	green	blue	yellow	white	grey	brown	violet	aqua	black	orange	pink
13-24	13	14	15	16	17	18	19	20	21	22	23	24
Fiber												
Code												
Color*	red	green	blue	yellow	white	grey	brown	violet	brown	natural	orange	pink

*Fiber with black mark to identify fibers 13-24

Applications

- Optical cable with aramid yarns reinforcement
- Customer connection, fully dielectric cable
- MTP/MPO termination cable
- LAN and FTTH networks
- Distribution network
- Inside house OLT connection
- Data Center connections cable

Features

- Aramid strength element
- 250 µm optical fibers (12-24)
- LSOH outer jacket

Operating temperature

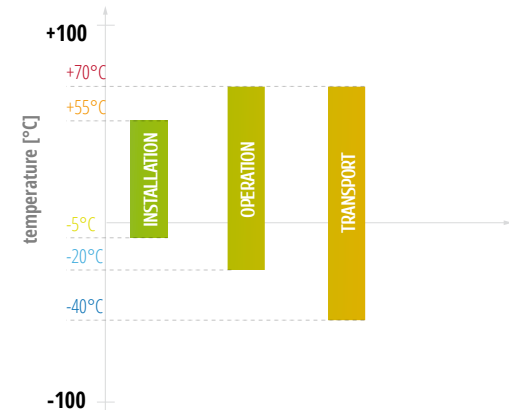

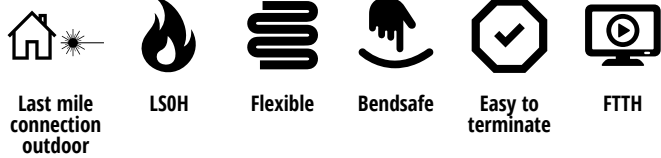
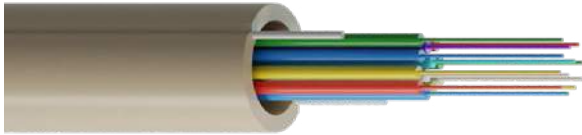

Cable structure

1. LSOH outer jacket
2. Dielectric strength members
3. 900 μm semi tight buffer (LSOH) with colored 250 μm optical fiber

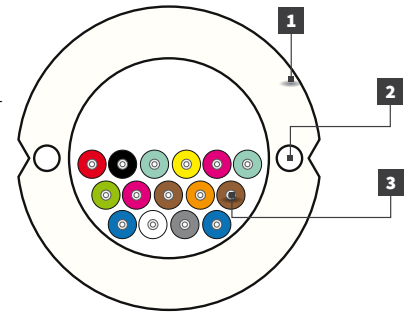

Configuration

EAC-RAs						
Version	Fibers	Buffers	\varnothing $\pm 5\%$ [mm]	Nominal weight $\pm 5\%$ [kg/km]	Max. tensile load [N]	Crush [N/10 cm]
					installation	
8F	8	8	8.7	68	400	1000
12F	12	12	8.7	72	400	
16F	16	16	12.0	98	600	
24F	24	24	12.0	106	600	

Other fiber counts available on demand

Available colors

F-FTTH (ACCORDING TO DIN VDE 0888 & IEC 60304)

1-12	1	2	3	4	5	6	7	8	9	10	11	12
Fiber	■	■	■	■	■	■	■	■	■	■	■	■
Buffer	■	■	■	■	■	■	■	■	■	■	■	■
Color 250 μm	red	blue	green	yellow	violet	white	orange	grey	brown	black	aqua	pink
Color 600/900 μm	red	blue	green	yellow	violet	white	orange	grey	brown	black	aqua	pink
13-24	13	14	15	16	17	18	19	20	21	22	23	24
Fiber	■	■	■	■	■	■	■	■	■	■	■	■
Code	■	■	■	■	■	■	■	■	■	■	■	■
Color 250 μm	red	blue	green	yellow	violet	white	orange	grey	brown	black	aqua	pink
Color* 600/900 μm	red	blue	green	yellow	violet	white	orange	grey	brown	dark green	aqua	pink

*Buffer with black mark to identify fibers 13-24

Applications

- Distribution cable
- For laying in risers
- FTTH feeder
- Easy access and installation

Features

- FRP strength members inside cable jacket
- Optical fibers in bundles
- 2-24 elements in cable
- LSOH UV resistant outer jacket (ivory by default, various colors available)

Operating temperature

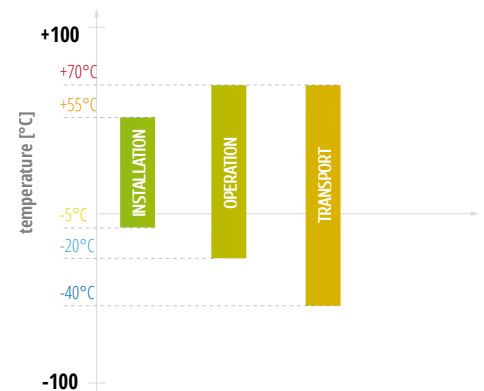

Fiber extraction up to 25 m

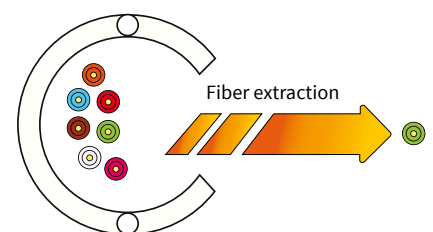

FTTH EAC-RAm

FTTH EAC-RAm

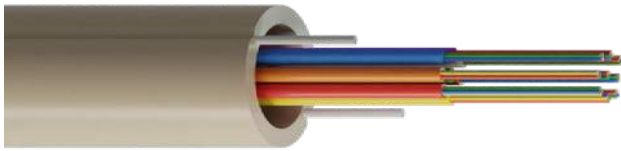

Cable structure

1. LSOH outer jacket
2. Dielectric strength members
3. Easy Section Modules with 250 μm colored fiber

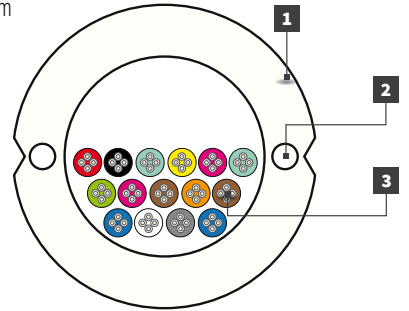

Configuration

EAC-RAm						
Version	Fibers	Easy Section Modules	Ø ± 5% [mm]	Nominal weight ±10% [kg/km]	Max. tensile load [N]	Crush [N/10 cm]
					ε=0.6% Δ α≤ 0.1 dB, reversible	
2F Easy Section Modules						
	12-18	6-9	8,7	69	400	500
	20-30	10-15	9,5	79	400	
	32-48	16-24	12,0	106	600	
4F Easy Section Modules						
	16-36	4-9	8,7	70	400	500
	40-48	10-12	9,5	78	400	
	52-60	13-15	10,5	85	400	
	64-96	16-24	12,0	110	600	
6F Easy Section Modules						
	12-24	2-4	8,7	70	400	500
	30-72	5-12	10,5	90	400	
	78-96	13-16	12,0	112	600	
	102-144	17-24	13,0	130	600	
8F Easy Section Modules						
	16-32	2-4	8,7	67	400	500
	40-96	5-12	10,5	89	400	
12F Easy Section Modules						
	24-48	2-4	8,7	70	400	500
	60-120	5-8	10,5	90	400	
	108-144	9-12	12,0	115	600	

Applications

- Distribution cable
- For laying in risers
- FTTH feeder
- Easy access and installation

Features

- FRP strength members inside cable jacket
- Optical fibers in bundles
- 2-24 elements in cable
- LSOH UV resistant outer jacket (Ivory by default, various color available)

Operating temperature

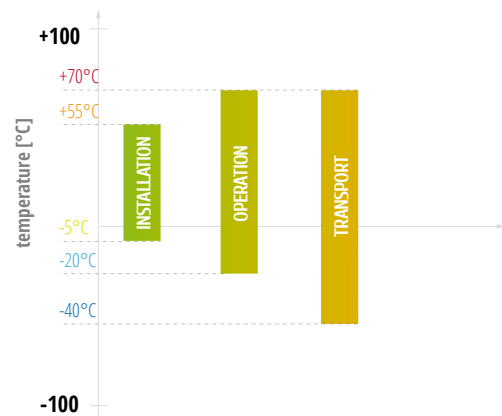

F-FTTH (ACCORDING TO DIN VDE 0888 & IEC 60304)

1-12	1	2	3	4	5	6	7	8	9	10	11	12
Fiber	■	■	■	■	■	■	■	■	■	■	■	■
Color 250 μm	red	blue	green	yellow	violet	white	orange	grey	brown	black	aqua	pink
1-12	1	2	3	4	5	6	7	8	9	10	11	12
Module	■	■	■	■	■	■	■	■	■	■	■	■
Color	red	blue	green	yellow	violet	white	orange	grey	brown	black	aqua	pink
13-24	13	14	15	16	17	18	19	20	21	22	23	24
Module	■	■	■	■	■	■	■	■	■	■	■	■
Color*	red	blue	green	yellow	violet	white	orange	grey	brown	dark green	aqua	pink

*Black mark to identify Easy Section Modules 13-24

Fiber extraction up to 25 m

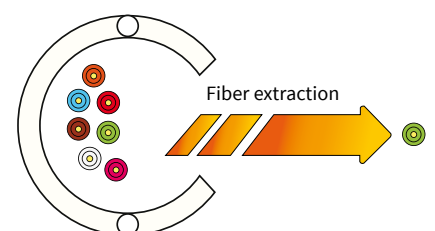

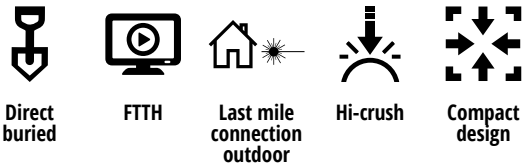

Cable structure

1. PP/HDPE outer jacket
2. Aramid yarns
3. Central loose tube (PBT) with 250 µm colored fibers in filling gel
4. Dielectric strength members in the jacket

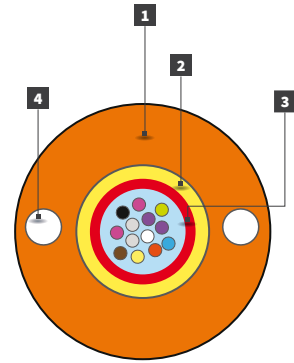

Configuration

DAC-BURRY							
Version	Fibers	Fibers per tube	Ø ± 5% [mm]	Nominal weight PE ± 5% [kg/km]	Max. tensile load [N]		Crush [N/10 cm]
					installation	operation	
1T x 2F	2	2	6.2	32	650	250	3500
1T x 4F	4	4	6.2	32			
1T x 6F	6	6	6.2	32			
1T x 8F	8	8	6.2	32			
1T x 12F	12	12	6.2	32			

Available colors

T-TELECOM (ACCORDING TO IEC 60304) - Fibers in tube

1-12	1	2	3	4	5	6	7	8	9	10	11	12
Code	■	■	■	■	■	■	■	■	■	■	■	■
Color	red	green	blue	white	violet	orange	grey	yellow	brown	pink	black	aqua

Applications

- Optical access cable with aramid yarns reinforcement
- Direct buried design
- Fully dielectric cable
- Last mile connection
- High crush resistance (3.5kN)
- Installation into existing ducts or direct buried

Features

- Central loose tube (PBT) with filling compound
- Up to 12 optical fibers (250 µm)
- Aramid yarns as strain relief and water absorbent
- Embedded FRP strength members
- Highly resistant outer jacket made of hard polyolefin material, UV resistant

Operating temperature

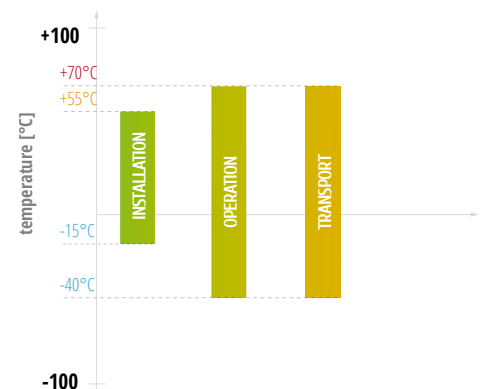



Cable structure

1. Outer jacket
2. Fiberglass yarns
3. Central loose tube (PBT) with 250 µm colored fibers in filling gel
4. Embedded strength members (FRP)

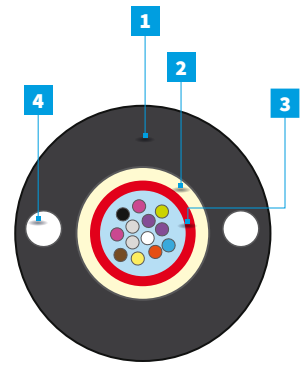

Direct buried



FTTH



Last mile connection outdoor



Hi-crush



Compact design

Configuration

DAC-BURRY-G							
Version	Total fibers	Fibers per tube	Ø ± 5% [mm]	Nominal weight PE ± 5% [kg/km]	Max. tensile load [N]		Crush [N/10 cm]
					installation	operation	
1T x 2-12F	2-12	2-12	6.0	29	450	150	3500
1T x 14-24F	14-24	14-24	6.5	35			

Available colors

T-TELECOM (ACCORDING TO IEC 60304) - Fibers in tube

1-12	1	2	3	4	5	6	7	8	9	10	11	12
Code	■	■	■	■	■	■	■	■	■	■	■	■
Color	red	green	blue	white	violet	orange	grey	yellow	brown	pink	black	aqua

Applications

- Optical access cable with glass yarns reinforcement
- Direct buried design
- Fully dielectric cable
- Last mile connection
- High crush resistance (3.5kN)
- Installation into existing ducts or direct buried

Features

- Central loose tube (PBT) with filling compound
- Up to 24 optical fibers (250 µm)
- Aramid yarns as strain relief and water absorbent
- Embedded FRP strength members
- Highly resistant outer jacket made of hard polyolefin material, UV resistant

Operating temperature

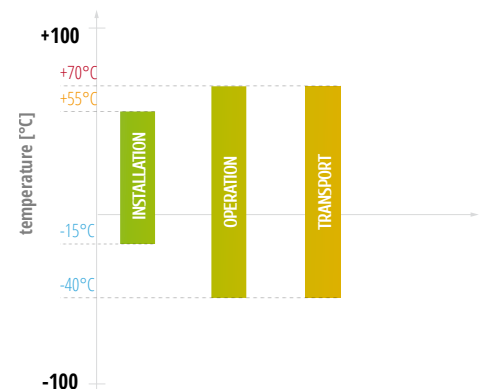

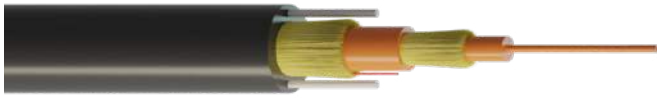

LSZH



Bendsafe



Easy to terminate



Easy-strip



Semi-tight



Datacenter



TRUE COLORS

Cable structure

1. HDPE UV resistant outer jacket
2. Aramid yarns
3. Inner LSZH jacket
4. FRP rods
5. Module with optical fibers
6. Ripcords

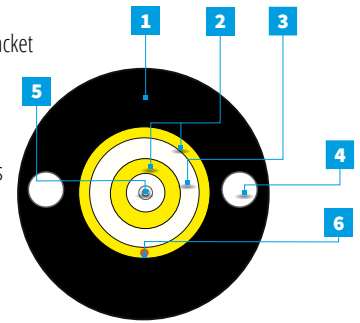

Configuration

VC-T601								
Version	Fibers	Fibers per module	Total elements	Ø [mm]	Nominal weight ±5% [kg/km]	Max. tensile load [N]		Crush [N/10 cm]
						allowed	static	
1F	1	1	1	max. 6.0	33	1200	300	500

Application and cable span characteristics



Wind load: max 72 km/h

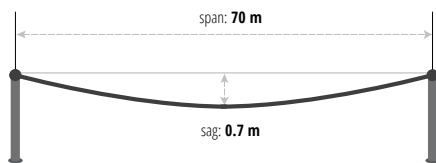

Ice load: max 5 mm

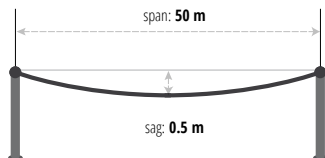

Applications

- Drop cable for FTTH networks
- Optical access cable with aramid yarns reinforcement
- Direct buried construction
- Fully dielectric cable
- Last mile connection
- Suitable for aerial, façade installation

Features

- Aramid yarns as strength and water absorbent elements
- Tight buffer or modules with optical fibers
- ITU-T G.657A2 optical fiber(s)
- Embedded strength members (FRP)
- Highly resistant outer jacket made of HDPE material
- UV stabilized
- Flexible internal LSZH subcable

Operating temperature

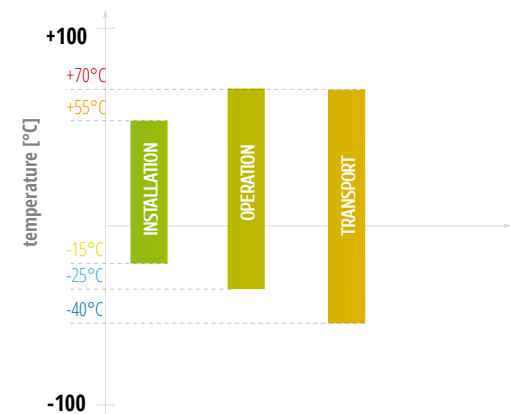

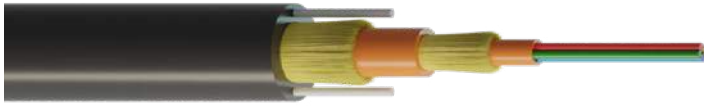

Cable structure

1. HDPE UV resistant outer jacket
2. Aramid yarns
3. Inner LSOH jacket
4. FRP rods
5. Module with optical fibers

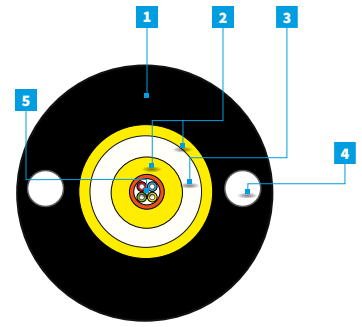

LSOH



Bendsafe



Easy to terminate



Easy-strip



Semi-tight



Datacenter



TRUE COLORS

Configuration

VC-T60								
Version	Fibers	Fibers per module	Total elements	Ø ± 5% [mm]	Nominal weight ±5% [kg/km]	Max. tensile load [N]		Crush [N/10 cm]
						allowed	static	
1-4F	1-4	1-4	1	6.0	30	800	250	2000

Applications

- Drop cable for FTTH networks
- Optical access cable with aramid yarns reinforcement
- Direct buried construction
- Fully dielectric cable
- Last mile connection

APPLICATION AND CABLE SPAN CHARACTERISTICS



NESC Light

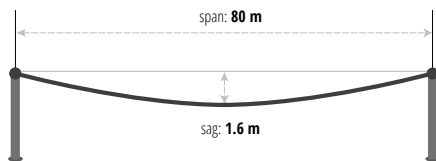

NESC Medium

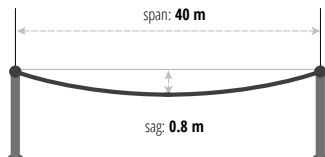

NESC Heavy

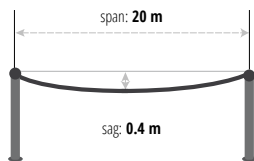

Features

- Aramid yarns as strength and water absorbent elements
- Easy strip buffer or modules with optical fibers
- Embedded strength members (FRP)
- Highly resistant outer jacket made of HDPE material
- UV stabilized

Operating temperature

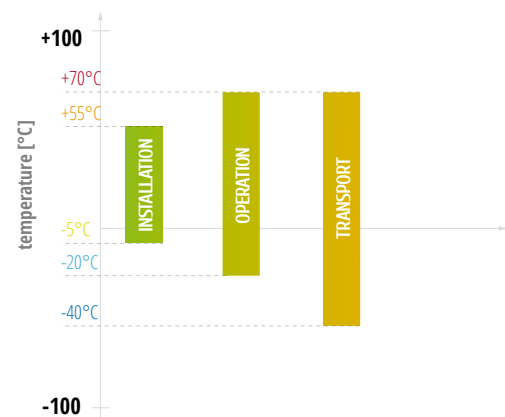

Microduct



TRENCH MICROCABLES



MICRODUCT MK-AX2

MICRODUCT MK-AX2

Cable structure

1. Polymeric jacket with low coefficient of friction
2. 250 μ m colored fibers

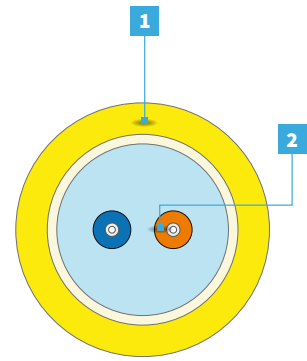

Microduct
Generation 1



FTTH



Last mile
connection
outdoor



Blowing
installation



Flexible



Compact
design



Bendsafe

Configuration

METROJET MK-AX2					
Version	Fibers	\varnothing $\pm 5\%$ [mm]	Nominal weight $\pm 10\%$ [kg/km]	Max. install. tension [N]	Crush [N/10 cm]
1T x 2F	2	1.1	1.2	15	100
1T x 4F	4	1.1	1.4		
1T x 6F	6	1.5	1.6		
1T x 8F	8	1.5	1.8		
1T x 10F	10	1.6	2.0		
1T x 12F	12	1.6	2.2		

Compatibility table

STANDARD MICRODUCT				
Version	Outer \varnothing [mm]	Inner \varnothing [mm]	MK-AX2	
			2-4F	6-12F
3/2.1	3	2.1	☑	-
5/3.5	5	3.5	☑	☑
7/5.5	7	5.5	☑	☑
10/8	10	8		
12/10	12	10		
14/12	14	12		
Fiber qty			2-12	

DIRECT BURIED DUCTS				
Version	Outer \varnothing [mm]	Inner \varnothing [mm]	MK-AX2	
			2-4F	6-12F
7/3.5	7	3.5	☑	
7/3.8	7	3.8	☑	
7/4	7	4	☑	
10/5.5	10	5.5	☑	
12/8	12	8	-	
14/10	14	10	-	
Fiber qty			2-12	

Available colors

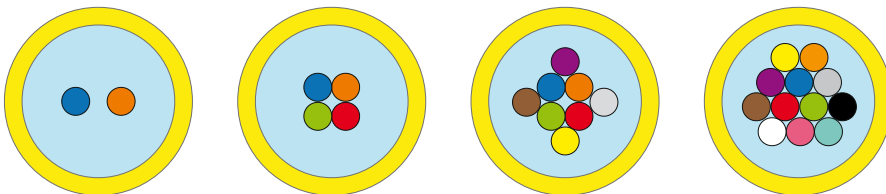

Applications

- Microduct air-blowing application
- Metro networks
- Flexible network design
- Distribution network

Features

- Polymeric jacket with low coefficient of friction
- Central tube without gel
- 250 μ m colored fibers

Operating temperature

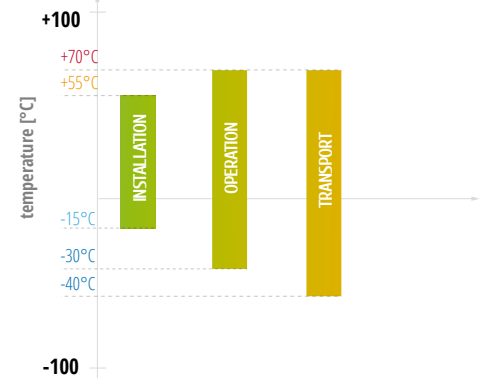

MICRODUCT MK-LX4

MICRODUCT MK-LX4



Cable structure

1. HDPE outer jacket
2. Loose tubes (PBT) with colored fibers in filling gel
3. Fillers
4. Central strength member (FRP)
5. Water blocking yarns
6. Water blocking yarns on strand element
7. Ripcord

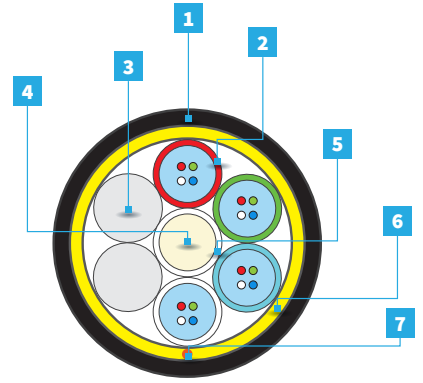

Optimal diameter



Low friction



Telecom



Blowing installation



Microduct Generation 1

Configuration

METROJET MK-LX4										
Version	Fibers	Fibers per tube	Total elements	Active tubes	Fillers	Ø ± 5% [mm]	Nominal weight ±10% [kg/km]	Max. tensile load [N]		Crush [N/10 cm]
								instal-lation	oper-ation	
1T x 4F	4	4	6	1	5	4.2	8	250	150	500
2T x 4F	8	4	6	2	4	4.2	8			
3T x 4F	12	4	6	3	3	4.2	9			
4T x 4F	16	4	6	4	2	4.2	9			
5T x 4F	20	4	6	5	1	4.2	10			
6T x 4F	24	4	6	6	0	4.2	10			

Other fiber counts available on demand

Compatibility table

STANDARD MICRODUCT			
Version	Outer Ø [mm]	Inner Ø [mm]	MK-LX4
3/2.1	3	2.1	-
5/3.5	5	3.5	-
7/5.5	7	5.5	☑
10/8	10	8	☑
12/10	12	10	☑
14/12	14	12	-
Fiber qty			4-24

DIRECT BURRIED DUCTS			
Version	Outer Ø [mm]	Inner Ø [mm]	MK-LX4
7/3.5	7	3.5	-
7/3.8	7	3.8	-
7/4	7	4	-
10/5.5	10	5.5	☑
12/8	12	8	☑
14/10	14	10	☑
Fiber qty			4-24

Available colors

T-TELECOM (ACCORDING TO IEC 60304) - Fibers

1-12	1	2	3	4
Code	■	■	■	■
Color	red	green	blue	white

T-TELECOM (ACCORDING TO IEC 60304) - Tubes

Tube	1	2	3	4	5	6
Code	■	■	■	■	■	■
Color	red	green	blue	white	violet	orange

*In case of lower fiber count some tubes can be replaced by fillers.

Applications

- Microduct cabling air-blowing system
- Metro networks
- Flexible network design
- Distribution network

Features

- HDPE, UV stabilized outer jacket with low friction
- Loose tubes (and fillers), SZ stranded around the CSM
- PBT tubes containing up to 4 optical fibers
- Smallest outer diameter for blowing into 5.5 mm (ID) ducts

Operating temperature

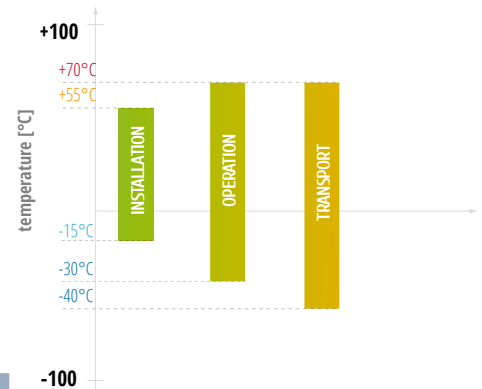

MICRODUCT MK-LX5

MICRODUCT MK-LX5



Optimal diameter



Low friction



Telecom



Blowing installation



Microduct Generation 1

Cable structure

1. Outer sheath: HDPE
2. Loose tubes (PBT) with optical fibers
3. Filling compound
4. Central strength member (FRP)
5. Water swellable yarns on FRP
6. Water swellable yarns on S-Z stranded cable core
7. Ripcord

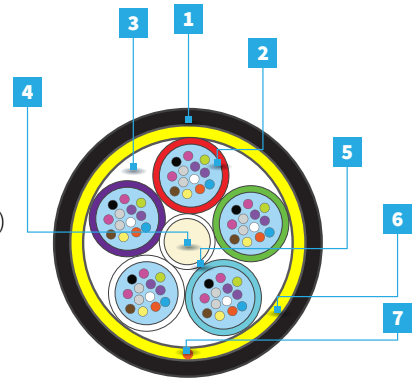

Configuration

METROJET MK-LX5									
Version	Fibers	Fibers per tube	Total elements	Active tubes	Ø ± 5% [mm]	Nominal weight ±10% [kg/km]	Max. tensile load [N]		Crush [N/10 cm]
							instal-lation	opera-tion	
1-5T x 4F	4-20	4	5	1-5	5.2	21	500	150	1000
1-5T x 6F	6-30	6	5	1-5	5.2	21			
1-5T x 8F	8-40	8	5	1-5	5.2	21			
1-5T x 10F	10-50	10	5	1-5	5.2	22			
1-5T x 12F	12-60	12	5	1-5	5.2	22			

Other fiber counts available on demand

Applications

- Microduct cabling air-blowing system application
- Metro networks
- Flexible network design
- Distribution network

Features

- HDPE, UV stabilized outer jacket with low coefficient of friction
- Loose tubes (and fillers), SZ stranded around the CSM
- Each PBT tube containing up to 12 optical fibers

Operating temperature

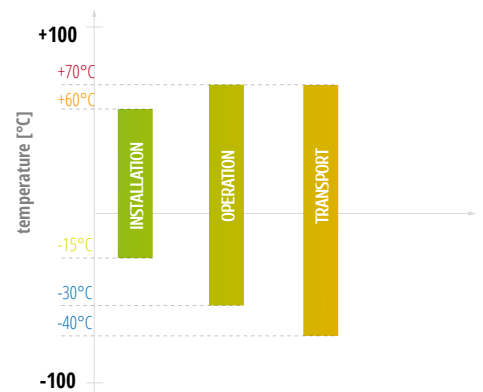

MICRODUCT MK-LXS6/7/8

MICRODUCT MK-LXS6/7/8



Cable structure

1. HDPE outer jacket
2. Loose tubes (PBT) with colored fibers in filling gel
3. Fillers
4. Central strength member (FRP)
5. Water blocking yarns on FRP
6. Water blocking yarns on strand element
7. Ripcord

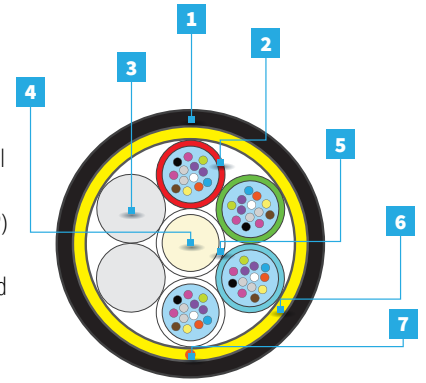

Optimal diameter



Low friction



Telecom



Blowing installation



Microduct Generation 1

Configuration

METROJET MK-LXS6										
Version	Fibers	Fibers per tube	Total elements	Active tubes	Fillers	Ø ± 5% [mm]	Nominal weight ±10% [kg/km]	Max. tensile load [N]		Crush [N/10 cm]
								installation	operation	
6T x 4F	24	4	6	6	0	5.3	18	650	200	500
6T x 6F	36	6	6	6	0	5.3	18			
6T x 8F	48	8	6	6	0	5.3	19			
6T x 10F	60	10	6	6	0	5.3	19			
4T x 12F	48	10	6	4	2	5.3	20			
6T x 12F	72	12	6	6	0	5.3	21			

METROJET MK-LXS7										
Version	Fibers	Fibers per tube	Total elements	Active tubes	Fillers	Ø ± 5% [mm]	Nominal weight ±10% [kg/km]	Max. tensile load [N]		Crush [N/10 cm]
								installation	operation	
8T x 4F	32	4	8	8	0	6.2	28	1200	350	500
8T x 6F	48	6	8	8	0	6.2	28			
8T x 8F	64	8	8	8	0	6.2	29			
8T x 10F	80	10	8	8	0	6.2	30			
8T x 12F	96	12	8	8	0	6.2	31			

METROJET MK-LXS8										
Version	Fibers	Fibers per tube	Total elements	Active tubes	Fillers	Ø ± 5% [mm]	Nominal weight ±10% [kg/km]	Max. tensile load [N]		Crush [N/10 cm]
								installation	operation	
12T x 4F	48	4	12	12	0	7.8	47	1500	550	500
12T x 6F	72	6	12	12	0	7.8	48			
12T x 8F	96	8	12	12	0	7.8	49			
12T x 10F	120	10	12	12	0	7.8	50			
12T x 12F	144	12	12	12	0	7.8	52			

Other fiber counts available on demand

Applications

- Microduct cabling air-blowing system
- Metro networks
- Flexible network design
- Distribution network

Features

- HDPE, UV stabilized outer jacket with low coefficient of friction
- Loose tubes (and fillers), SZ stranded around the CSM
- PBT tubes containing up to 12 optical fibers

Operating temperature

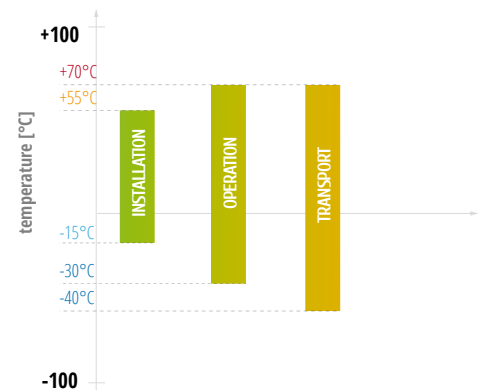



Cable structure

1. HDPE outer jacket
2. Loose tubes (PBT) with colored fibers in filling gel
3. Fillers
4. Central strength member (FRP)
5. Water blocking yarns on FRP
6. Water blocking tape on strand element
7. Ripcord

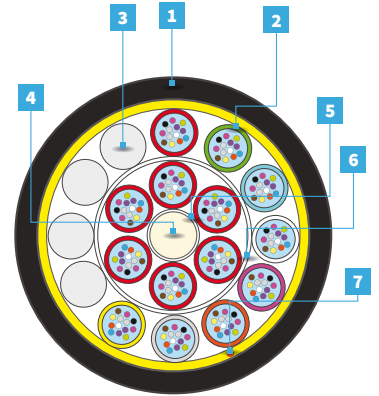

Optimal diameter



Low friction



Telecom



Blowing installation



Microduct Generation 1

Configuration

METROJET MK-LXS9										
Version	Fibers	Fibers per tube	Total elements	Active tubes	Fillers	Ø ± 5% [mm]	Nominal weight ±10% [kg/km]	Max. tensile load [N]		Crush [N/10 cm]
								instal-lation	opera-tion	
14T x 12F	168	12	18	14	4	8.7	53	650	200	500
16T x 12F	192	12	18	16	2	8.7	54			
18T x 12F	216	12	18	18	0	8.7	55			

METROJET MK-LXS10										
Version	Fibers	Fibers per tube	Total elements	Active tubes	Fillers	Ø ± 5% [mm]	Nominal weight ±10% [kg/km]	Max. tensile load [N]		Crush [N/10 cm]
								instal-lation	opera-tion	
24T x 12F	288	12	24	24	0	9.3	72	1000	250	500

Other fiber counts available on demand

Applications

- Microduct cabling air-blowing system
- Metro networks
- Flexible network design
- Distribution network

Features

- HDPE, UV stabilized outer jacket with low coefficient of friction
- Loose tubes (and fillers), SZ stranded around the CSM
- PBT tubes containing up to 12 optical fibers

Operating temperature

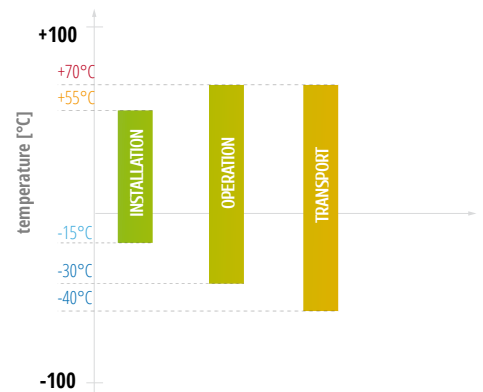

MICRODUCT MK-LX6

MICRODUCT MK-LX6



Cable structure

1. HDPE outer jacket
2. Loose tubes (PBT) with colored fibers in filling gel
3. Fillers
4. Central strength member (FRP)
5. Water blocking yarns on FRP
6. Water blocking yarns on strand element
7. Ripcord

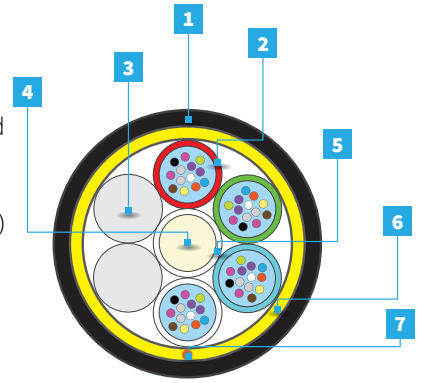

Optimal diameter



Low friction



Telecom



Blowing installation



Microduct Generation 1

Configuration

METROJET MK-LX6										
Version	Fibers	Fibers per tube	Total elements	Active tubes	Fillers	Ø ± 5% [mm]	Nominal weight ±10% [kg/km]	Max. tensile load [N]		Crush [N/10 cm]
								installation	operation	
1T x 4F	4	4	6	1	5	5.6	28	750	250	1000
1T x 6F	6	6	6	1	5	5.6	28			
1T x 8F	8	8	6	1	5	5.6	28			
2T x 6F	12	6	6	2	4	5.6	29			
4T x 6F	24	6	6	4	2	5.6	29			
6T x 6F	36	6	6	6	0	5.6	29			
1T x 12F	12	12	6	1	5	5.6	30			
2T x 12F	24	12	6	2	4	5.6	30			
3T x 12F	36	12	6	3	3	5.6	30			
4T x 12F	48	12	6	4	2	5.6	31			
5T x 12F	60	12	6	5	1	5.6	32			
6T x 12F	72	12	6	6	0	5.6	33			

Other fiber counts available on demand

Available colors

T-TELECOM (ACCORDING TO IEC 60304) - Fibers

1-12	1	2	3	4	5	6	7	8	9	10	11	12
Code	■	■	■	■	■	■	■	■	■	■	■	■
Color	red	green	blue	white	violet	orange	grey	yellow	brown	pink	black	aqua

T-TELECOM (ACCORDING TO IEC 60304) - Tubes

Tube	1	2	3	4	5	6
Code	■	■	■	■	■	■
Color	red	green	blue	white	violet	orange

*In case of lower fiber count some tubes can be replaced by fillers.

Applications

- Microduct cabling air-blowing system
- Metro networks
- Flexible network design
- Distribution network

Features

- HDPE, UV stabilized outer jacket with low friction
- Loose tubes (and fillers), SZ stranded around the CSM
- PBT tubes containing 4-12 optical fibers
- Smallest diameter for blowing into 8 mm (ID) ducts

Operating temperature

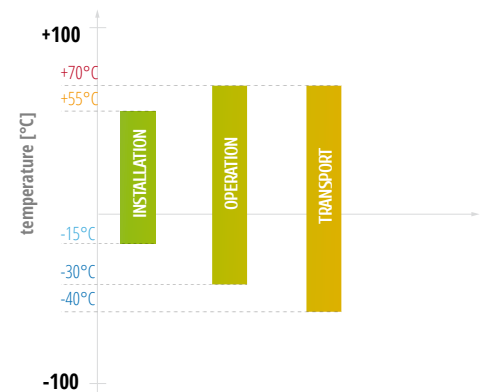

MICRODUCT MK-LX7

MICRODUCT MK-LX7



Cable structure

1. HDPE outer jacket
2. Loose tubes (PBT) with colored fibers in filling gel
3. Fillers
4. Central strength member (FRP)
5. Water blocking yarns on FRP
6. Water blocking yarns on strand element
7. Ripcord

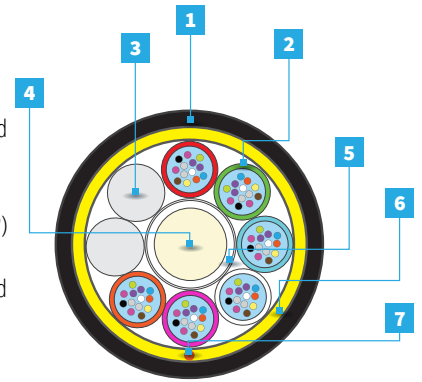

Optimal diameter



Low friction



Telecom



Blowing installation



Microduct Generation 1

Configuration

METROJET MK-LX7										
Version	Fibers	Fibers per tube	Total elements	Active tubes	Fillers	Ø ± 5% [mm]	Nominal weight ±10% [kg/km]	Max. tensile load [N]		Crush [N/10 cm]
								instal-lation	opera-tion	
8T x 4F	32	4	8	8	0	6.7	36	1600	600	1000
8T x 6F	48	6	8	8	0	6.7	37			
8T x 8F	64	8	8	8	0	6.7	38			
8T x 12F	96	12	8	8	0	6.7	39			

Other fiber counts available on demand

Available colors

T-TELECOM (ACCORDING TO IEC 60304) - Fibers

1-12	1	2	3	4	5	6	7	8	9	10	11	12
Code	■	■	■	■	■	■	■	■	■	■	■	■
Color	red	green	blue	white	violet	orange	grey	yellow	brown	pink	black	aqua

T-TELECOM (ACCORDING TO IEC 60304) - Tubes

Tube	1	2	3	4	5	6	7	8
Code	■	■	■	■	■	■	■	■
Color	red	green	blue	white	violet	orange	grey	yellow

*In case of lower fiber count some tubes can be replaced by fillers.

Applications

- Microduct cabling air-blowing system
- Metro networks
- Flexible network design
- Distribution network

Features

- HDPE, UV stabilized outer jacket with low friction
- Loose tubes (and fillers), SZ stranded around the CSM
- PBT tubes containing 4-12 optical fibers
- Smallest diameter for blowing into 8* and 10 mm (ID) ducts

* - blowing range may be lower

Operating temperature

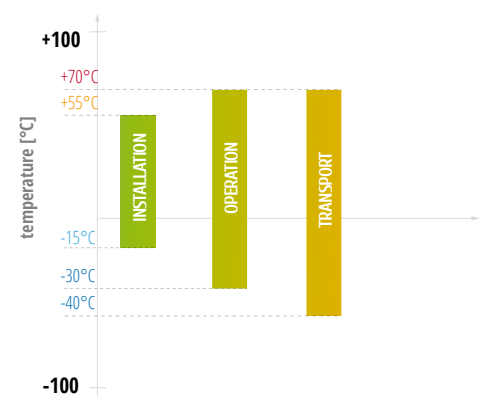

MICRODUCT MK-LX8

MICRODUCT MK-LX8



Cable structure

1. HDPE outer jacket
2. Loose tubes (PBT) with colored fibers in filling gel
3. Fillers
4. Central strength member (FRP)
5. Water blocking yarns on FRP
6. Water blocking yarns on strand element
7. Ripcord

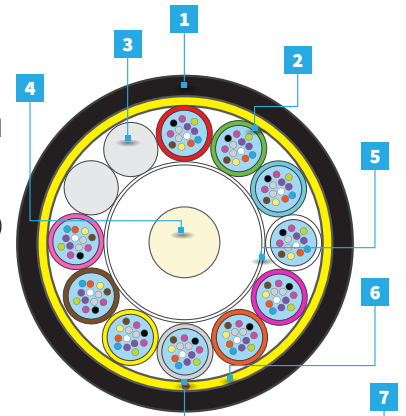

Optimal diameter



Low friction



Telecom



Blowing installation



Microduct Generation 1

Configuration

METROJET MK-LX8										Crush [N/10 cm]
Version	Fibers	Fibers per tube	Total elements	Active tubes	Fillers	Ø ± 5% [mm]	Nominal weight ±10% [kg/km]	Max. tensile load [N]		
								installation	operation	
1T x 12F	12	12	12	1	11	8.6	53	2500	600	1000
2T x 12F	24	12	12	2	10	8.6	54			
3T x 12F	36	12	12	3	9	8.6	55			
4T x 12F	48	12	12	4	8	8.6	56			
5T x 12F	60	12	12	5	7	8.6	57			
6T x 12F	72	12	12	6	6	8.6	57			
8T x 12F	96	12	12	8	4	8.6	59			
12T x 12F	144	12	12	12	0	8.6	62			

Other fiber counts available on demand

Available colors

T-TELECOM (ACCORDING TO IEC 60304) - Fibers

1-12	1	2	3	4	5	6	7	8	9	10	11	12
Code	■	■	■	■	■	■	■	■	■	■	■	■
Color	red	green	blue	white	violet	orange	grey	yellow	brown	pink	black	aqua

T-TELECOM (ACCORDING TO IEC 60304) - Tubes

Tube	1	2	3	4	5	6	7	8	9	10	11	12
Code	■	■	■	■	■	■	■	■	■	■	■	■
Color	red	green	blue	white	violet	orange	grey	yellow	brown	pink	black	aqua

*In case of lower fiber count some tubes can be replaced by fillers.

Applications

- Microduct cabling air-blowing system
- Metro networks
- Flexible network design
- Distribution network

Features

- HDPE, UV stabilized outer jacket with low friction
- Loose tubes (and fillers), SZ stranded around the CSM
- PBT tubes containing 4-12 optical fibers
- Smallest diameter for blowing into 12 mm (ID) ducts

Operating temperature

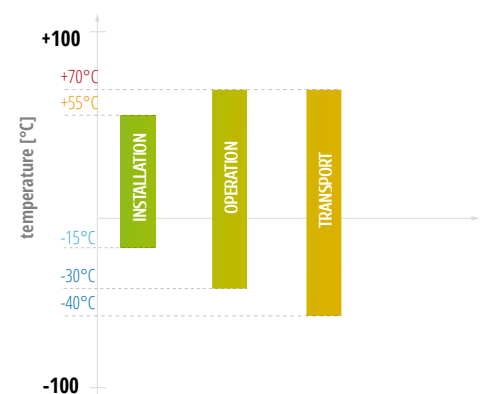

MICRODUCT MK-LX9

MICRODUCT MK-LX9



Optimal diameter



Low friction



Telecom



Blowing installation



Microduct Generation 1

Cable structure

1. HDPE outer jacket
2. Loose tubes (PBT) with colored fibers in filling gel
3. Fillers
4. Central strength member (FRP)
5. Water blocking yarns on FRP
6. Water blocking yarns on strand element
7. Ripcord

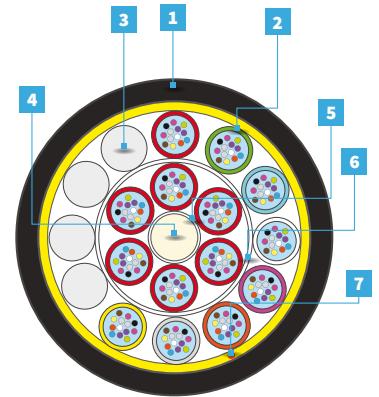

Configuration

METROJET MK-LX9										
Version	Fibers	Fibers per tube	Total elements	Active tubes	Fillers	Ø ± 5% [mm]	Nominal weight ±10% [kg/km]	Max. tensile load [N]		Crush [N/10 cm]
								instal-lation	opera-tion	
14T x 12F	168	12	18	14	4	8.8	62	750	250	1000
16T x 12F	192	12	18	16	2	8.8	63			
18T x 12F	216	12	18	18	0	8.8	64			

Other fiber counts available on demand

Available colors

T-TELECOM (ACCORDING TO IEC 60304) - Fibers

1-12	1	2	3	4	5	6	7	8	9	10	11	12
Code	■	■	■	■	■	■	■	■	■	■	■	■
Color	red	green	blue	white	violet	orange	grey	yellow	brown	pink	black	aqua

T-TELECOM (ACCORDING TO IEC 60304) - Tubes

Tube	1	2	3	4	5	6	7	8	9	10	11	12
Code	■	■	■	■	■	■	■	■	■	■	■	■
Color	red	green	blue	white	violet	orange	grey	yellow	brown	pink	black	aqua

*In cable with a multi-layer construction color of the tubes will be repeated in second layer

**In case of lower fiber count some tubes can be replaced by fillers

Applications

- Microduct cabling air-blowing system
- Metro networks
- Flexible network design
- Distribution network

Features

- HDPE, UV stabilized outer jacket with low friction
- Loose tubes (and fillers), SZ stranded around the CSM
- PBT tubes containing up to 12 optical fibers
- Smallest diameter for blowing into 12 mm (ID) ducts

Operating temperature

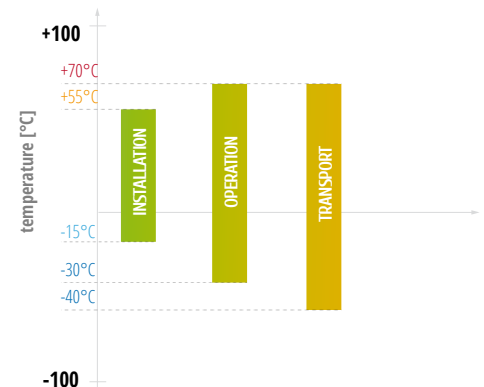

MICRODUCT MK-LX11

MICRODUCT MK-LX11



Cable structure

1. HDPE outer jacket
2. Fillers
3. Loose tubes (PBT) with colored fibers in filling gel
4. Central strength member (FRP)
5. Water blocking yarns on FRP
6. Water blocking yarns on strand element
7. Ripcord

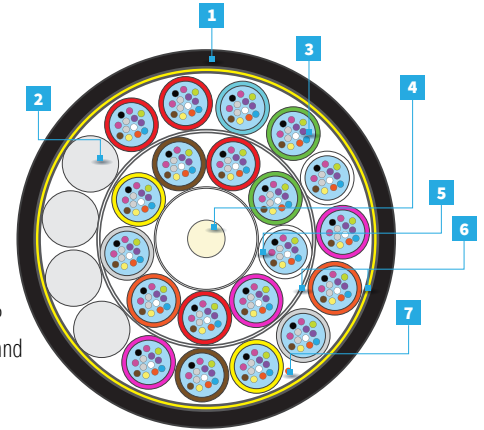

Optimal diameter



Low friction



Telecom



Blowing installation



Microduct Generation 1

Configuration

METROJET MK-LX11										
Version	Fibers	Fibers per tube	Total elements	Active tubes	Fillers	Ø ± 5% [mm]	Nominal weight ±10% [kg/km]	Max. tensile load [N]		Crush [N/10 cm]
								instal-lation	opera-tion	
20T x 12F	240	12	24	20	4	10.8	85	1000	350	1000
22T x 12F	264	12	24	22	2	10.8	86			
24T x 12F	288	12	24	24	0	10.8	87			

Other fiber counts available on demand

Available colors

T-TELECOM (ACCORDING TO IEC 60304) - Fibers

1-12	1	2	3	4	5	6	7	8	9	10	11	12
Code	■	■	■	■	■	■	■	■	■	■	■	■
Color	red	green	blue	white	violet	orange	grey	yellow	brown	pink	black	aqua

T-TELECOM (ACCORDING TO IEC 60304) - Tubes

Tube	1	2	3	4	5	6	7	8	9	10	11	12
Code	■	■	■	■	■	■	■	■	■	■	■	■
Color	red	green	blue	white	violet	orange	grey	yellow	brown	pink	black	aqua

*In cable with a multi-layer construction color of the tubes will be repeated in second layer

**In case of lower fiber count some tubes can be replaced by fillers

Applications

- Microduct cabling air-blowing system
- Metro networks
- Flexible network design
- Distribution network

Features

- HDPE, UV stabilized outer jacket with low friction
- Loose tubes (and fillers), SZ stranded around the CSM
- PBT tubes containing up to 12 optical fibers
- Smallest outer diameter for blowing into 12 mm (ID) ducts

Operating temperature

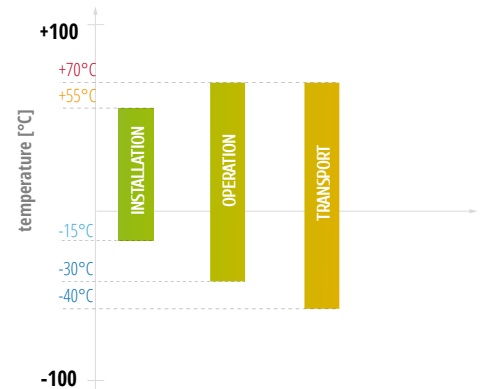

Telecom Duct

TELECOM DUCT BDC-MSA

TELECOM DUCT BDC-MSA

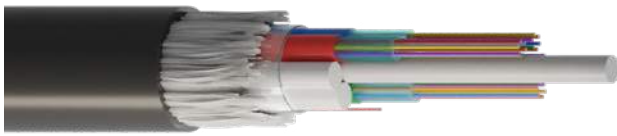

Telecom



Duct



Basic Rodent Protection

Cable structure

1. HDPE outer jacket
2. Fiberglass yarns
3. PET tape
4. Water blocking yarns on FRP
5. Central strength member (FRP)
6. Loose tubes (PBT) with colored fibers in filling gel
7. Fillers
8. Ripcord

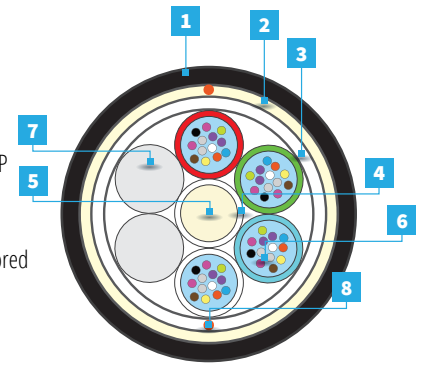

Configuration

TELECOM DUCT BDC-MSA									
Version	Fibers	Fibers per tube	Total elements	Active tubes	Ø ± 5% [mm]	Nominal weight PE ±5% [kg/km]	Max. tensile load [N]		Crush [N/10 cm]
							installation	operation	
1T x 12F	12	12	6	1	8.2	50	1500	550	1500
1-6T x 4F	4-24	4	6	1-6	8.2	50	1550	780	
1T x 6F	6	6	6	1	8.2	50	1550	780	
2T x 6F	12	6	6	2	8.2	50	1550	780	
2T x 12F	24	12	6	2	8.2	51	1500	550	
4T x 6F	24	6	6	4	8.2	51	1550	780	
3T x 12F	36	12	6	3	8.2	52	1500	550	
6T x 6F	36	6	6	6	8.2	53	1550	780	
4T x 12F	48	12	6	4	8.2	53	1500	550	
5T x 12F	60	12	6	5	8.2	54	1500	550	
6T x 12F	72	12	6	6	8.2	54	1500	550	
8T x 4F	48	4	8	8	9.3	70	1650	750	
8T x 12F	96	12	8	8	9.3	71	1620	750	
11T x 12F	132	12	12	11	11.5	102	1620	850	
12T x 12F	144	12	12	12	11.5	104	1620	850	
13T x 12F	156	12	14	13	12.6	126	2100	850	
14T x 12F	168	12	14	14	12.6	126	2100	850	

Other fiber counts available on demand

Available colors

T-TELECOM (ACCORDING TO IEC 60304) - Fibers

1-12	1	2	3	4	5	6	7	8	9	10	11	12
Code	■	■	■	■	■	■	■	■	■	■	■	■
Color	red	green	blue	white	violet	orange	grey	yellow	brown	pink	black	aqua

T-TELECOM (ACCORDING TO IEC 60304) - Tubes

Tube	1	2	3	4	5	6	7	8	9	10	11	12
Code	■	■	■	■	■	■	■	■	■	■	■	■
Color	red	green	blue	white	violet	orange	grey	yellow	brown	pink	black	aqua

*In case of lower fiber count some tubes can be replaced by fillers.

Applications

- Installation into existing ducts
- High tensile and crush performance
- Fully dielectric cable

Features

- HDPE outer jacket
- Optical fibers
- Jelly into the Loose tube
- Loose tubes (PBT Ø 1.8 mm) with filling compound
- PET tape to prevent moisture into the cable

Operating temperature

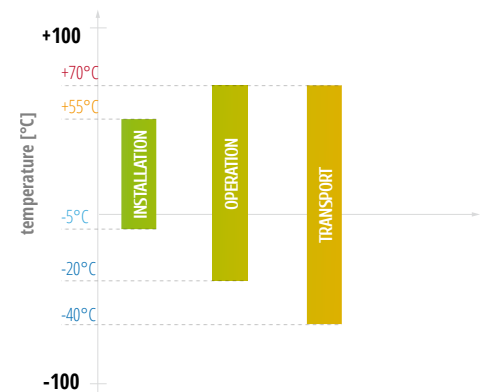

TELECOM DUCT BDC-MIB

TELECOM BDC-MIB

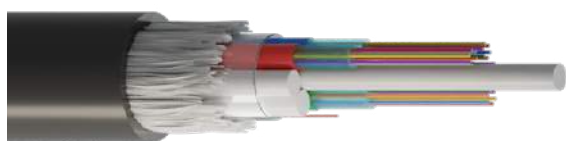

Cable structure

1. HDPE outer jacket
2. Water blocking fiberglass yarns
3. Water blocking yarns
4. Water blocking tape
5. Central strength member (FRP)
6. Loose tubes (PBT) with colored fibers in filling gel
7. Fillers
8. Ripcord

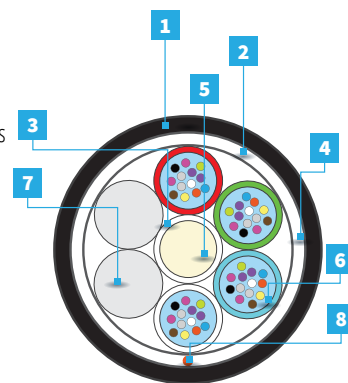

Telecom



Duct



Basic Rodent Protection

Configuration

TELECOM DUCT BDC-MIB									
Version	Fibers	Fibers per tube	Total elements	Active tubes	Ø ± 5% [mm]	Nominal weight ±10% [kg/km]	Max. tensile load [N]		Crush [N/10 cm]
							instal-lation	opera-tion	
1-6T x 6F	6-36	6	6	1-6	8.8	63	2800	1500	1500
1-6T x 12F	12-72	12	6	1-6	8.8	66	2800	1000	
8T x 6F	48	6	8	8	10.0	77	2800	1500	
8T x 12F	96	12	8	8	10.0	82	2800	1000	
12T x 12F	144	12	12	12	12.2	117	2800	1000	
16-18T x 12F	192-216	12	18	16-18	12.6	122	2800	1000	
20-24T x 12F	240-288	12	24	20-24	14.2	156	2800	1000	

Other fiber counts available on demand

Available colors

T-TELECOM (ACCORDING TO IEC 60304) - Fibers

1-12	1	2	3	4	5	6	7	8	9	10	11	12
Code	■	■	■	■	■	■	■	■	■	■	■	■
Color	red	green	blue	white	violet	orange	grey	yellow	brown	pink	black	aqua

T-TELECOM (ACCORDING TO IEC 60304) - Tubes

Tube	1	2	3	4	5	6	7	8	9	10	11	12
Code	■	■	■	■	■	■	■	■	■	■	■	■
Color	red	green	blue	white	violet	orange	grey	yellow	brown	pink	black	aqua

*In cable with a multi-layer construction color of the tubes will be repeated in second layer

**In case of lower fiber count some tubes can be replaced by fillers

Applications

- For installation into existing duct or directly buried
- Fully dielectric cable
- Basic rodent protection

Features

- FRP strength and anti-buckling rod
- Dry yarns to prevent moisture into the cable
- Loose tubes (PBT Ø 1,8mm) with filling compound
- Optical fibers
- Fibreglass yarns as tensile elements
- UV stabilized HDPE jacket

Operating temperature

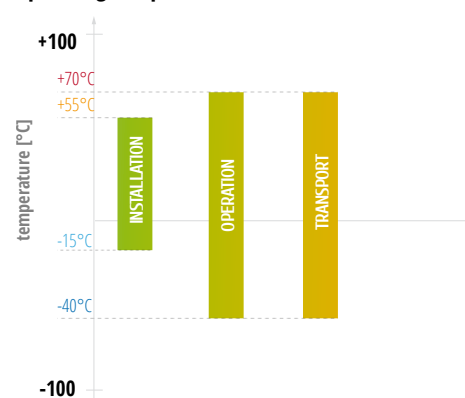

TELECOM DUCT BDC-C0

TELECOM DUCT BDC-C0

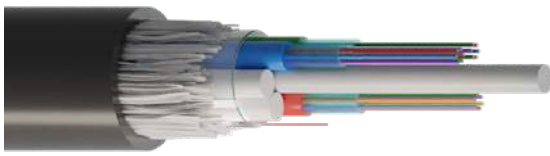

Cable structure

1. HDPE outer jacket
2. Water blocking fiberglass yarns
3. Water blocking yarns
4. Water blocking tape
5. Central strength member (FRP)
6. Loose tubes (PBT) with colored fibers in filling gel
7. Fillers
8. Ripcord

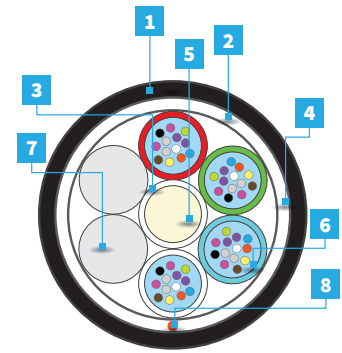

Telecom



Duct



Basic Rodent Protection

Configuration

TELECOM DUCT BDC-C0									
Version	Fibers	Fibers per tube	Total elements	Active tubes	Ø ± 5% [mm]	Nominal weight ±10% [kg/km]	Max. tensile load [N]		Crush [N/10 cm]
							instal-lation	opera-tion	
1T x 4F	4	4	6	1	10.0	71	2100	1300	2000
1T x 6F	6	6	6	2	10.0	71	2100	1300	
2T x 6F	12	6	6	2					
4T x 6F	24	6	6	4					
1T x 12F	12	12	6	1	10.0	74	2000	1000	
2T x 12F	24	12	6	2					
3T x 12F	36	12	6	3					
4T x 12F	48	12	6	4					
5T x 12F	60	12	6	5					
6T x 12F	72	12	6	6					
8T x 12F	96	12	8	8	11.3	97	2100	1000	
12T x 12F	144	12	12	12	13.8	144	2200	1100	
16T x 12F	192	12	18	16	14.2	148	2200	1100	
18T x 12F	216	12	18	18	14.2	150	2200	1100	
24T x 12F	288	12	24	24	16.2	190	2500	1200	

Other fiber counts available on demand

Available colors

T-TELECOM (ACCORDING TO IEC 60304) - Fibers

1-12	1	2	3	4	5	6	7	8	9	10	11	12
Code	■	■	■	■	■	■	■	■	■	■	■	■
Color	red	green	blue	white	violet	orange	grey	yellow	brown	pink	black	aqua

T-TELECOM (ACCORDING TO IEC 60304) - Tubes

Tube	1	2	3	4	5	6	7	8	9	10	11	12
Code	■	■	■	■	■	■	■	■	■	■	■	■
Color	red	green	blue	white	violet	orange	grey	yellow	brown	pink	black	aqua

*In cable with a multi-layer construction color of the tubes will be repeated in second layer

**In case of lower fiber count some tubes can be replaced by fillers

Applications

- Installation into existing ducts
- High tensile and crush performance
- Fully dielectric cable
- Basic rodent protection

Features

- FRP strength and anti-buckling element
- Optical fibers
- Loose tube with filling compound (PBT Ø 2.0 mm)
- Dry yarns to prevent moisture into the cable
- Fiberglass yarns as tensile elements
- UV stabilized HDPE jacket

Operating temperature

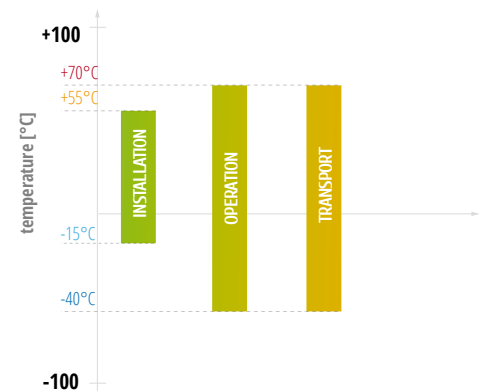

TELECOM DUCT BDC-CI

TELECOM BDC-CI

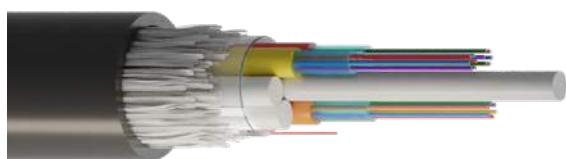

Cable structure

1. HDPE outer jacket
2. Water blocking fiberglass yarns
3. Water blocking yarns
4. Water blocking tape
5. Central strength member (FRP)
6. Loose tubes (PBT) with colored fibers in filling gel
7. Fillers
8. Ripcord

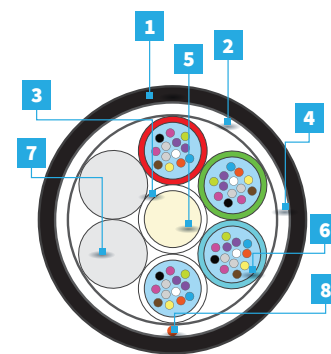

Telecom



Duct



Basic Rodent Protection

Configuration

TELECOM DUCT BDC-CI									
Version	Fibers	Fibers per tube	Total elements	Active tubes	Ø ± 5% [mm]	Nominal weight ±10% [kg/km]	Max. tensile load [N]		Crush [N/10 cm]
							instal-lation	opera-tion	
1T x 4F	4	4	6	1	10.0	74	2800	1700	2000
1T x 6F	6	6	6	1	10.0	74	2800	1700	
2T x 6F	12	6	6	2	10.0	74	2800	1700	
1T x 12F	12	12	6	1	10.0	73	2700	1200	
4Tx 6F	24	6	6	4	10.0	74	2800	1600	
2T x 12F	24	12	6	2	10.0	75	2700	1200	
3Tx 12F	36	12	6	3	10.0	82	2700	1200	
4T x 12F	48	12	6	4					
6T x 12F	72	12	6	6					
8T x 12F	96	12	8	8					
12T x 12F	144	12	12	12	13.8	146	2700	1200	
13T x 12F	156	12	18	13	14.2	149	2900	1400	
14T x 12F	168	12	18	14	14.2	150			
15T x 12F	180	12	18	15	14.2	151			
16T x 12F	192	12	18	16	14.2	152			
17T x 12F	204	12	18	17	14.2	153			
18T x 12F	216	12	18	18	14.2	154			
24T x 12F	288	12	24	24	16.3	191	2900	1400	

Other fiber counts available on demand

Available colors

T-TELECOM (ACCORDING TO IEC 60304) - Fibers

1-12	1	2	3	4	5	6	7	8	9	10	11	12
Code	■	■	■	■	■	■	■	■	■	■	■	■
Color	red	green	blue	white	violet	orange	grey	yellow	brown	pink	black	aqua

T-TELECOM (ACCORDING TO IEC 60304) - Tubes

Tube	1	2	3	4	5	6	7	8	9	10	11	12
Code	■	■	■	■	■	■	■	■	■	■	■	■
Color	red	green	blue	white	violet	orange	grey	yellow	brown	pink	black	aqua

*In cable with a multi-layer construction color of the tubes will be repeated in second layer

Applications

- Installation into existing ducts
- High tensile and crush performance
- Fully dielectric cable
- Basic rodent protection

Features

- FRP strength and anti-buckling element
- Optical fibers
- Loose tube with filling compound (PBT Ø 2.0 mm)
- Dry yarns to prevent moisture into the cable
- Fiberglass yarns as tensile elements
- UV stabilized HDPE jacket

Operating temperature

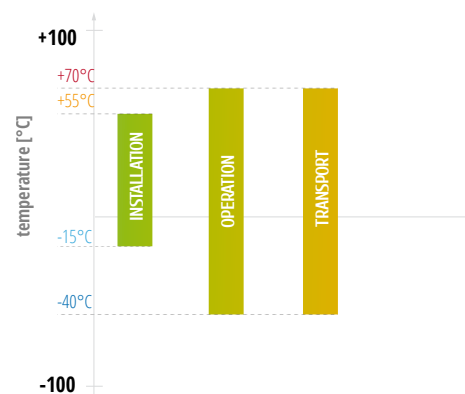

TELECOM DUCT BDC-CK

TELECOM DUCT BDC-CK

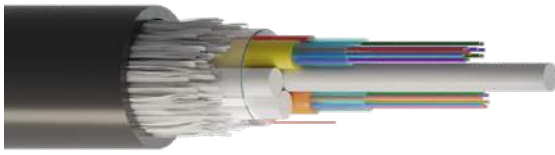

Telecom



Duct



Basic Rodent Protection

Cable structure

1. HDPE outer jacket
2. Water blocking fiberglass yarns
3. Water blocking yarns
4. Water blocking tape
5. Central strength member (FRP)
6. Loose tubes (PBT) with colored fibers in filling gel
7. Fillers
8. Ripcord

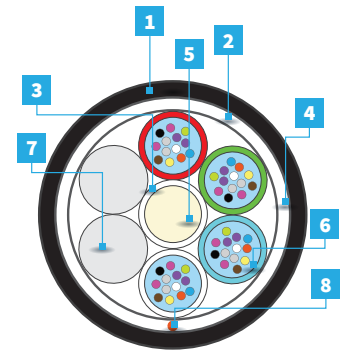

Configuration

TELECOM DUCT BDC-CK									
Version	Fibers	Fibers per tube	Total elements	Active tubes	Ø ± 5% [mm]	Nominal weight ±10% [kg/km]	Max. tensile load [N]		Crush [N/10 cm]
							instal-lation	opera-tion	
1T x 4F	4	4	6	1	10.1	77	4000	2400	2000
1T x 6F	6	6	6	1	10.1	78			
1T x 8F	8	8	6	1	10.1	79			
1T x 10F	10	10	6	1	10.1	80			
1T x 12F	12	12	6	1	10.2	81	4100	2000	
2T x 6F	12	6	6	2	10.1	78	4000	2400	
2T x 12F	24	12	6	2	10.2	81	4100	2000	
4T x 6F	24	6	6	4	10.1	79	4000	2400	
3T x 12F	36	12	6	3	10.2	82	4100	2000	
6T x 6F	36	6	6	6	10.1	82	4000	2400	
4T x 12F	48	12	6	4	10.2	83	4100	2000	
8T x 6F	48	6	8	8	11.4	98	4100	2700	
5T x 12F	60	12	6	5	10.2	84	4100	2000	
6T x 12F	72	12	6	6	10.2	85			
8T x 12F	96	12	8	8	11.4	104	4200	2300	
12T x 12F	144	12	12	12	13.9	151	4200	2000	
16T x 12F	192	12	18	16	14.1	191	4100	1800	
18T x 12F	216	12	18	18	14.1	191			
24T x 12F	288	12	24	24	15.9	240			

Other fiber counts available on demand

Available colors

T-TELECOM (ACCORDING TO IEC 60304) - Fibers

1-12	1	2	3	4	5	6	7	8	9	10	11	12
Code	■	■	■	■	■	■	■	■	■	■	■	■
Color	red	green	blue	white	violet	orange	grey	yellow	brown	pink	black	aqua

T-TELECOM (ACCORDING TO IEC 60304) - Tubes

Tube	1	2	3	4	5	6	7	8	9	10	11	12
Code	■	■	■	■	■	■	■	■	■	■	■	■
Color	red	green	blue	white	violet	orange	grey	yellow	brown	pink	black	aqua

*In cable with a multi-layer construction color of the tubes will be repeated in second layer

**In case of lower fiber count some tubes can be replaced by fillers

Applications

- Installation into existing ducts
- High tensile and crush performance
- Fully dielectric cable
- Basic rodent protection

Features

- FRP strength and anti-buckling element
- Optical fibers
- Loose tube with filling compound (PBT Ø 2.0 mm)
- Dry yarns to prevent moisture into the cable
- Fiberglass yarns as tensile elements
- UV stabilized HDPE jacket

Operating temperature

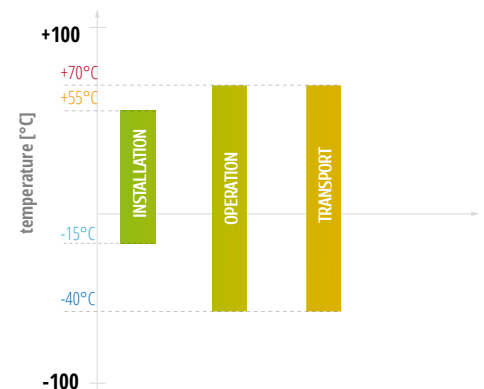

TELECOM DUCT BDC-DI

TELECOM BDC-DI

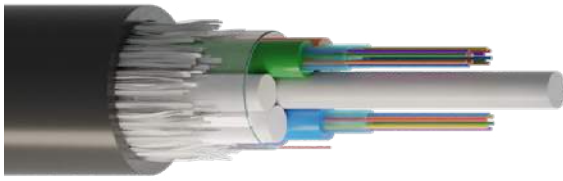

Cable structure

1. HDPE outer jacket
2. Water blocking fiberglass yarns
3. Water blocking yarns
4. Water blocking tape
5. Central strength member (FRP)
6. Loose tubes (PBT) with colored fibers in filling gel
7. Fillers
8. Ripcord

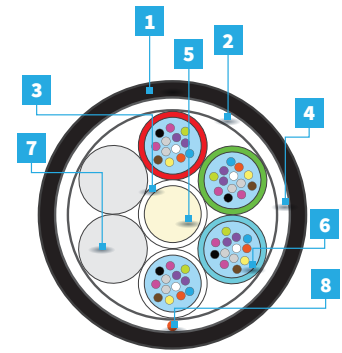

Telecom



Duct



Basic Rodent Protection

Configuration

TELECOM DUCT BDC-DI									
Version	Fibers	Fibers per tube	Total elements	Active tubes	Ø ± 5% [mm]	Nominal weight ±10% [kg/km]	Max. tensile load [N]		Crush [N/10 cm]
							instal-lation	opera-tion	
1-6T x 6F	6-36	6	6	1-6	11,5	98	3400	2400	4000
1-6T x 12F	12-72	12	6	1-6	11,5	99	3000	1900	
8T x 12F	96	12	8	8	13,1	126	3000	1900	
12T x 12F	144	12	12	12	16,2	193	3000	1900	
16T x 12F	192	12	18	16	17,0	195	3000	1900	
18T x 12F	216	12	18	18	17,0	197	3000	1900	
20T x 12F	240	12	24	20	19,4	252	3000	1900	
24T x 12F	288	12	24	24	19,4	260	3000	1900	

Other fiber counts available on demand

Available colors

T-TELECOM (ACCORDING TO IEC 60304) - Fibers

1-12	1	2	3	4	5	6	7	8	9	10	11	12
Code	■	■	■	■	■	■	■	■	■	■	■	■
Color	red	green	blue	white	violet	orange	grey	yellow	brown	pink	black	aqua

T-TELECOM (ACCORDING TO IEC 60304) - Tubes

Tube	1	2	3	4	5	6	7	8	9	10	11	12
Code	■	■	■	■	■	■	■	■	■	■	■	■
Color	red	green	blue	white	violet	orange	grey	yellow	brown	pink	black	aqua

*In cable with a multi-layer construction color of the tubes will be repeated in second layer

**In case of lower fiber count some tubes can be replaced by fillers

Applications

- For installation into existing duct or directly buried
- Fully dielectric cable
- Basic rodent protection

Features

- FRP strength and anti-buckling element
- Dry yarns and tape to prevent moisture into the cable
- Loose tube (PBT Ø 2.5mm) with filling compound
- Optical fibers
- Fillers (if applicable)
- Water-swollable tape
- Fibreglass yarns as strain relief
- UV stabilized PE sheath
- Sheath options: LSOH, PA etc.

Operating temperature

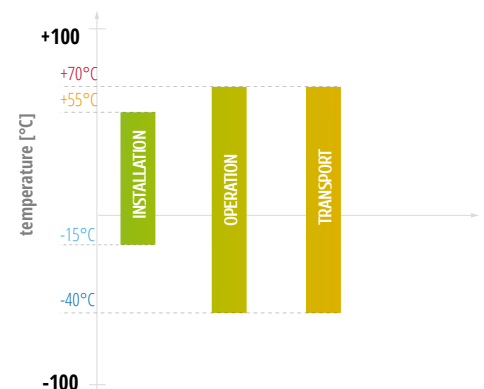

TELECOM DUCT BDC-DK

TELECOM DUCT BDC-DK

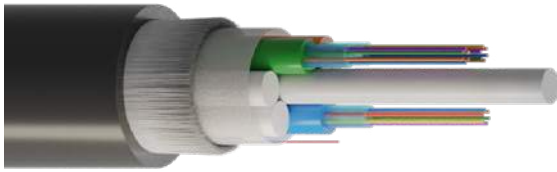

Cable structure

1. PE sheath
2. Glass yarns
3. Filling compound
4. Water swellable yarns
5. Water swellable tape
6. Central strength member (FRP)

7. Loose tubes (PBT)
8. Optical fibers
9. Ripcord



Telecom



Basic Rodent Protection



Duct

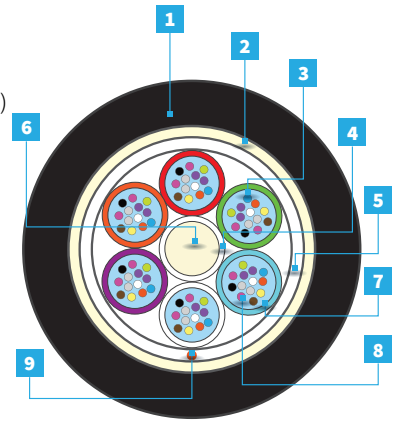

Configuration

TELECOM DUCT BDC-FK									
Version	Fibers	Fibers per tube	Total elements	Active tubes	Ø ± 5% [mm]	Nominal weight ±10% [kg/km]	Max. tensile load [N]		Crush [N/10 cm]
							instal-lation	opera-tion	
1-6T x 4F	4-24	4	6	1-6	11.5	98	4200	2800	4000
1-6T x 6F	6-36	6	6	1-6	11.5	99	4200	2800	
1-6T x 12F	12-72	12	6	1-6	11.5	100	4000	2400	
8T x 12F	96	12	8	8	13.1	129	4200	2600	
12T x 12F	144	12	12	12	16.2	196	4200	2600	
16T x 12F	192	12	18	16	17.0	198	4000	2400	
18T x 12F	216	12	18	18	17.0	202	4000	2400	
20T x 12F	240	12	24	20	19.4	255	4200	2600	
24T x 12F	288	12	24	24	19.4	263	4200	2600	

Other fiber counts available on demand

Available colors

T-TELECOM (ACCORDING TO IEC 60304) - Fibers

1-12	1	2	3	4	5	6	7	8	9	10	11	12
Code	■	■	■	■	■	■	■	■	■	■	■	■
Color	red	green	blue	white	violet	orange	grey	yellow	brown	pink	black	aqua

T-TELECOM (ACCORDING TO IEC 60304) - Tubes

Tube	1	2	3	4	5	6	7	8	9	10	11	12
Code	■	■	■	■	■	■	■	■	■	■	■	■
Color	red	green	blue	white	violet	orange	grey	yellow	brown	pink	black	aqua

*In cable with a multi-layer construction color of the tubes will be repeated in second layer

**In case of lower fiber count some tubes can be replaced by fillers

Applications

- For installation into existing duct or directly buried
- Fully dielectric cable
- Basic rodent protection

Features

- FRP strength and anti-buckling element
- Dry yarns and tape to prevent moisture into the cable
- Loose tube (PBT Ø 2.5mm) with filling compound
- Optical fibers
- Fillers (if applicable)
- Water-swellable tape
- Fibreglass yarns as strain relief
- UV stabilized PE sheath
- Sheath options: LSOH, PA etc.

Operating temperature

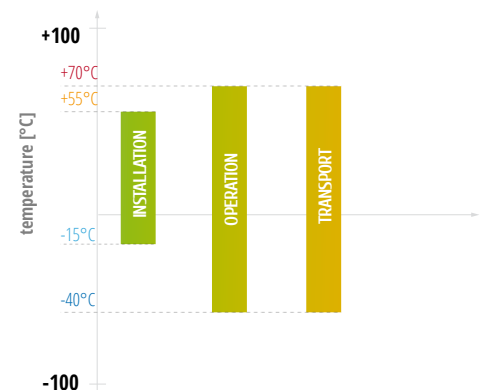

TELECOM DUCT DDC-SI

TELECOM DUCT DDC-SI



Telecom



High Rodent Protection



Duct



Direct buried

Cable structure

1. HDPE outer jacket
2. Fiberglass yarns
3. HDPE inner jacket
4. Water blocking yarns
5. Central strength member (FRP)
6. Loose tubes (PBT) with colored fibers in filling gel
7. Fillers
8. Ripcords

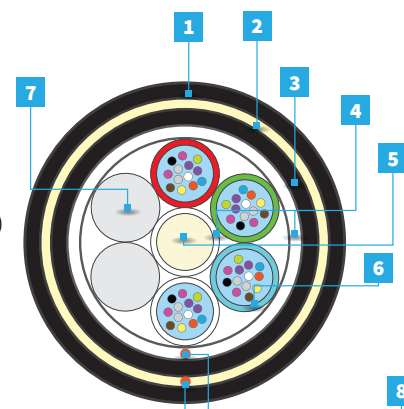

Configuration

TELECOM DUCT DDC-SI									
Version	Fibers	Fibers per tube	Total elements	Active tubes	Ø ± 5% [mm]	Nominal weight ±10% [kg/km]	Max. tensile load [N]		Crush [N/10 cm]
							al-lowed	static	
1-6T x 4F	4-24	4	6	1-6	9.3	67	2800	800	2000
8T x 4F	32	4	8	8	10.3	83	2700	650	
1-6T x 6F	6-36	6	6	1-6	9.4	68	2800	800	
8T x 6F	48	6	8	8	10.4	85	2800	800	
1-6T x 12F	12-72	12	6	1-6	9.4	73	2700	650	
8T x 12F	96	12	8	8	10.4	88	2700	670	
12T x 12F	144	12	12	12	12.3	122	2800	670	

Other fiber counts available on demand

Available colors

T-TELECOM (ACCORDING TO IEC 60304) - Fibers

1-12	1	2	3	4	5	6	7	8	9	10	11	12
Code	■	■	■	■	■	■	■	■	■	■	■	■
Color	red	green	blue	white	violet	orange	grey	yellow	brown	pink	black	aqua

T-TELECOM (ACCORDING TO IEC 60304) - Tubes

Tube	1	2	3	4	5	6	7	8	9	10	11	12
Code	■	■	■	■	■	■	■	■	■	■	■	■
Color	red	green	blue	white	violet	orange	grey	yellow	brown	pink	black	aqua

*In cable with a multi-layer construction color of the tubes will be repeated in second layer

**In case of lower fiber count some tubes can be replaced by fillers

Applications

- Installation into existing ducts
- High tensile and crush performance
- Fully dielectric cable
- High rodent protection

Features

- FRP strength and anti-buckling element
- Optical fibers
- Loose tube (PBT Ø 1.6mm) with filling compound
- Dry yarns to prevent moisture into the cable
- Fiberglass yarns as tensile and water absorbent elements
- Double HDPE jacket
- LSOH, PA etc. outer jacket option

Operating temperature

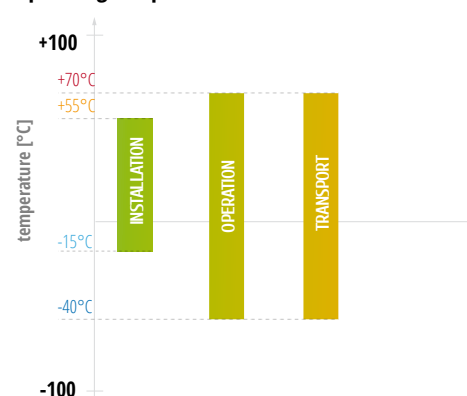

TELECOM DUCT DDC-CI

TELECOM DUCT DDC-CI

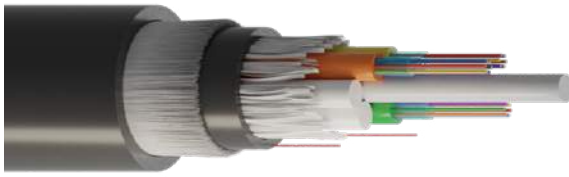

Cable structure

1. HDPE outer jacket
2. Fiberglass yarns
3. HDPE inner jacket
4. Water blocking yarns
5. Central strength member (FRP)
6. Loose tubes (PBT) with colored fibers in filling gel
7. Fillers
8. Ripcords

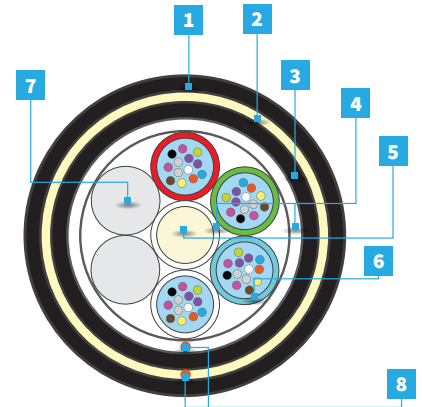

Telecom



High Rodent Protection



Duct



Direct buried



Hi-crush

Configuration

TELECOM DUCT DDC-CI									
Version	Fibers	Fibers per tube	Total elements	Active tubes	Ø ± 5% [mm]	Nominal weight ±10% [kg/km]	Max. tensile load [N]		Crush [N/10 cm]
							al-lowed	static	
1-6T x 4F	4 - 24	4	6	1-6	11.7	73	4400	2600	3500
1-6T x 6F	6 - 36	6	6	1-6	11.7	73	4400	2600	
1-6T x 12F	12 - 72	12	6	1-6	11.8	105	4100	2000	
8T x 6F	48	6	8	8	13.0	124	4100	2300	
8T x 12F	96	12	8	8	13.0	128	4100	2000	
12T x 12F	144	12	12	12	15.5	180	4600	2200	
16T x 12F	192	12	16	16	15.9	185	4600	2200	
18T x 12F	216	12	18	18	15.9	187	4600	2200	
24T x 12F	288	12	24	24	17.6	193	5000	2600	

Other fiber counts available on demand

Available colors

T-TELECOM (ACCORDING TO IEC 60304) - Fibers

1-12	1	2	3	4	5	6	7	8	9	10	11	12
Code	■	■	■	■	■	■	■	■	■	■	■	■
Color	red	green	blue	white	violet	orange	grey	yellow	brown	pink	black	aqua

T-TELECOM (ACCORDING TO IEC 60304) - Tubes

Tube	1	2	3	4	5	6	7	8	9	10	11	12
Code	■	■	■	■	■	■	■	■	■	■	■	■
Color	red	green	blue	white	violet	orange	grey	yellow	brown	pink	black	aqua

*In cable with a multi-layer construction color of the tubes will be repeated in second layer

**In case of lower fiber count some tubes can be replaced by fillers

Applications

- Installation into existing ducts
- High tensile and crush performance
- Fully dielectric cable
- High rodent protection

Features

- FRP strength and anti-buckling element
- Optical fibers
- Loose tube with filling compound (PBT Ø 2.0 mm)
- Dry yarns and tape to prevent moisture into the cable
- Glass yarns as tensile elements
- Double HDPE jacket
- LSOH, PA etc. outer jacket option

Operating temperature

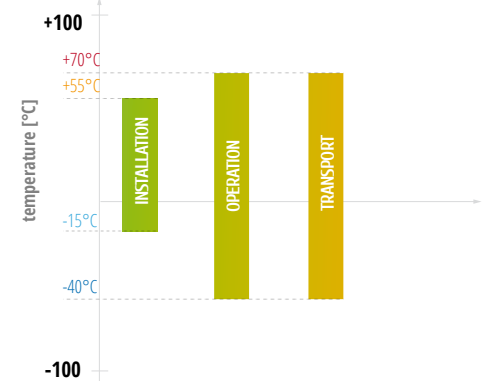

TELECOM DUCT MDC-FM

TELECOM DUCT MDC-FM

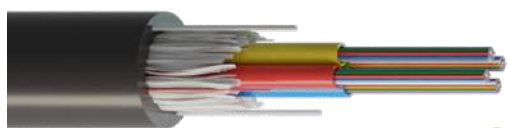

Telecom



High Rodent Protection



Duct

Cable structure

1. PE outer jacket (black)
2. Water blocking and strength elements
3. FRP rods incorporated in outer jacket
4. Optical fibers
5. LSOH module
6. Ripcord

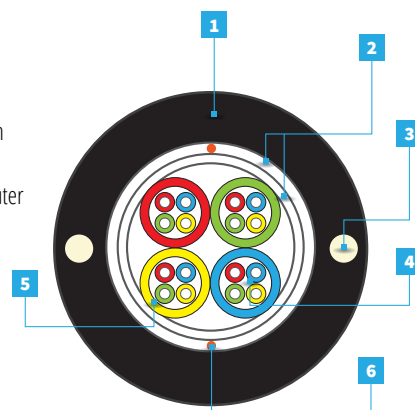

Configuration

TELECOM DUCT MDC-FM									
Version	Fibers	Fibers per tube	Total elements	Active modules	Ø ± 0.3	Nominal weight ±10% [kg/km]	Max. tensile load [N]		Crush [N/10 cm]
							al- lowed	static	
1M x 12F	12	12	1	1	5.9 (max 6.4)	30	800	400	2000
2M x 12F	24	12	2	2	7.0 (max 7.5)	40	800	400	
3M x 12F	36	12	3	3	7.2 (max 7.7)	42	800	400	
4M x 12F	48	12	4	4	7.9 (max 8.4)	49	1000	500	
6M x 12F	72	12	6	6	9.0 (max 9.5)	55	1600	800	
8M x 12F	96	12	8	8	10.2 (max 10.7)	85	1800	900	
12M x 12F	144	12	12	12	11.2 (max 11.7)	110	2200	1100	
16M x 12F	192	12	16	16	13.0 (max 13.5)	140	2300	1100	
18M x 12F	216	12	18	18	14.0 (max 14.5)	155	2500	1200	
24M x 12F	288	12	24	24	14.5 (max 15.0)	147	2700	1300	

Other fiber counts available on demand

Available colors

T-TELECOM (ACCORDING TO IEC 60304) - Fibers

1-12	1	2	3	4	5	6	7	8	9	10	11	12
Code	■	■	■	■	■	■	■	■	■	■	■	■
Color	red	green	blue	white	violet	orange	grey	yellow	brown	pink	black	aqua

T-TELECOM (ACCORDING TO IEC 60304) - Tubes

Tube	1	2	3	4	5	6	7	8	9	10	11	12
Code	■	■	■	■	■	■	■	■	■	■	■	■
Color	red	green	blue	white	violet	orange	grey	yellow	brown	pink	black	aqua

*In cable with a multi-layer construction color of the tubes will be repeated in second layer

**In case of lower fiber count some tubes can be replaced by fillers

Applications

- Duct cable
- FTTH access networks
- Fully dielectric cable

Features

- LSOH modules with 12 pcs of optical fibers each
- Water swellable and tensile strength elements
- FRP rods as strength elements (incorporated in outer jacket)
- UV resistant black HDPE sheath
- Orange polyester rip cord

Operating temperature

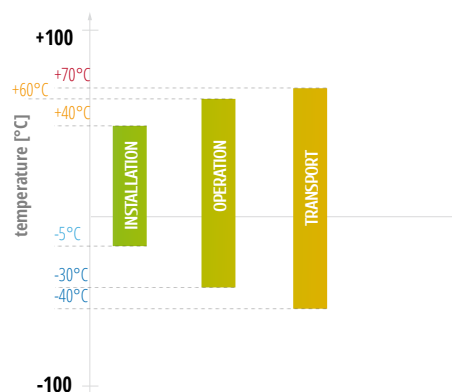

ARMORED CABLES



**Extreme
Rodent
Protection**

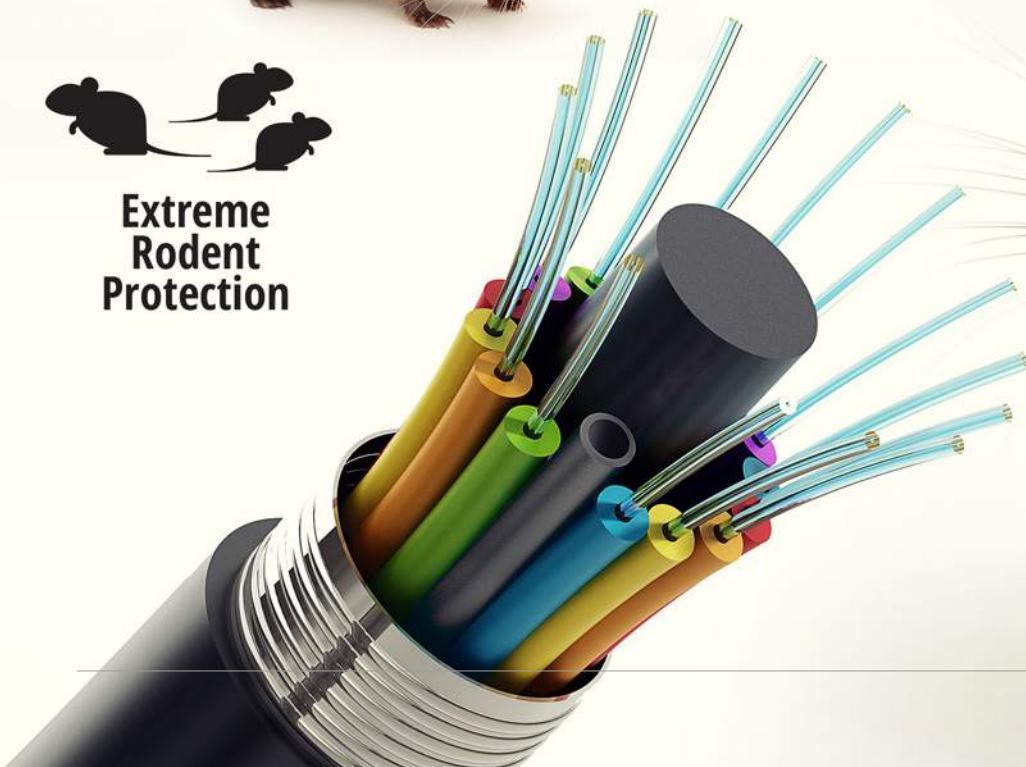

ARMORED SSC-CI

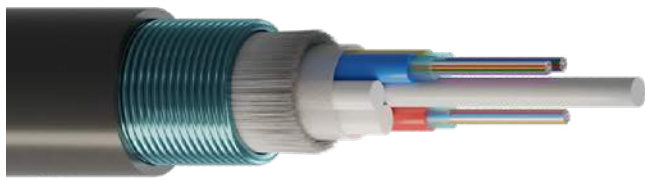

Telecom



High Rodent Protection



Duct



Direct buried

Configuration

ARMORED SSC-CI									
Version	Fibers	Fibers per tube	Total elements	Active modules	Ø ± 0.3	Nominal weight ±10% [kg/km]	Max. tensile load [N]		Crush [N/10 cm]
							al- lowed	static	
1-6T x 12F	12-72	12	6	1-6	11.4	154	2700	1400	3500
8T x 12F	96	12	8	8	12.6	187	2700	1400	
12T x 12F	144	12	12	12	14.2	250	2700	1400	
16T x 12F	192	12	16	16	15.2	264	2700	1400	
18T x 12F	216	12	18	18	15.2	267	2700	1400	
20T x 12F	240	12	24	20	17.2	305	2700	1400	
24T x 12F	288	12	24	24	17.2	309	2700	1400	

Other fiber counts available on demand

Available colors

T-TELECOM (ACCORDING TO IEC 60304) - Fibers

1-12	1	2	3	4	5	6	7	8	9	10	11	12
Code	■	■	■	■	■	■	■	■	■	■	■	■
Color	red	green	blue	white	violet	orange	grey	yellow	brown	pink	black	aqua

T-TELECOM (ACCORDING TO IEC 60304) - Tubes

Tube	1	2	3	4	5	6	7	8	9	10	11	12
Code	■	■	■	■	■	■	■	■	■	■	■	■
Color	red	green	blue	white	violet	orange	grey	yellow	brown	pink	black	aqua

*In cable with a multi-layer construction color of the tubes will be repeated in second layer

**In case of lower fiber count some tubes can be replaced by fillers

ARMORED SSC-CI

Cable structure

1. LSOH sheath
2. Corrugated steel tape
3. Fiberglass yarns
4. Water swellable yarns and tape
5. Central strength member (FRP)
6. Loose tube with optical fibers in filling compound
7. Fillers
8. Ripcord

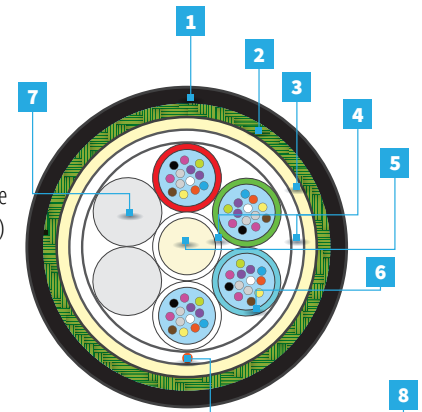

Applications

- For installation into existing duct or directly buried
- Extreme rodent protection

Features

- FRP strength and anti-buckling element
- Dry yarns and tape to prevent moisture into the cable
- Loose tube (PBT Ø 2.0mm) with filling compound
- Optical fibers
- Fillers (if applicable)
- Water-swellable tape
- Fiberglass yarns as strain relief
- Corrugated steel tape armouring
- UV stabilized LSOH sheath / black or grey (other colours available on demand)
- Sheath options: PE, PA etc.

Operating temperature

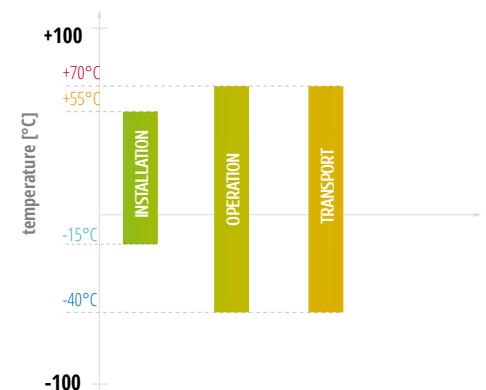

ARMORED SSC-T30U

ARMORED SSC-T30U



Cable structure

1. PE sheath
2. Corrugated steel tape
3. Fiberglass yarns
4. Loose tube (PBT) with optical fibers in filling compound
5. Ripcord

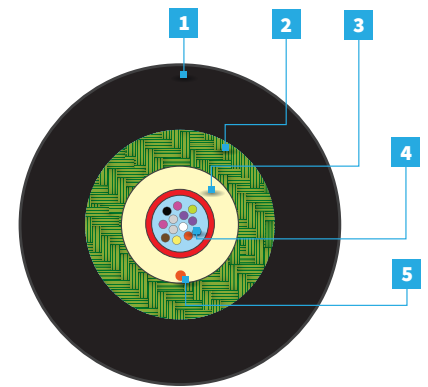

Telecom



Rodent Protection High



Duct



Direct buried

Configuration

ARMORED SSC-T30U									
Version	Fibers	Fibers per tube	Total elements	Active tubes	Ø ± 0.3	Nominal weight ±10% [kg/km]	Max. tensile load [N]		Crush [N/10 cm]
							al-lowed	static	
1T x 2-24F	2-24	2-24	1	1	7.6	69	1500	750	3000
1T x 2-24F LSOH	2-24	2-24	1	1	7.6	84	1500	750	

Other designs available on demand

Available colors

T-TELECOM (ACCORDING TO IEC 60304) - Fibers

1-12	1	2	3	4	5	6	7	8	9	10	11	12
Code	■	■	■	■	■	■	■	■	■	■	■	■
Color	red	green	blue	white	violet	orange	grey	yellow	brown	pink	black	aqua

T-TELECOM (ACCORDING TO IEC 60304) - Tubes

Tube	1	2	3	4	5	6	7	8	9	10	11	12
Code	■	■	■	■	■	■	■	■	■	■	■	■
Color	red	green	blue	white	violet	orange	grey	yellow	brown	pink	black	aqua

*In cable with a multi-layer construction color of the tubes will be repeated in second layer

**In case of lower fiber count some tubes can be replaced by fillers

Applications

- For installation into existing duct or directly buried
- Extreme rodent protection

Features

- Loose tube (PBT Ø 3.0mm) with filling compound
- Optical fibers
- Fibreglass yarns as strain relief
- Corrugated steel tape armoring
- UV stabilized PE sheath (black), option: LSOH sheath (grey by default, other colors available)
- option: LSOH sheath (grey by default, other colors available)

Operating temperature

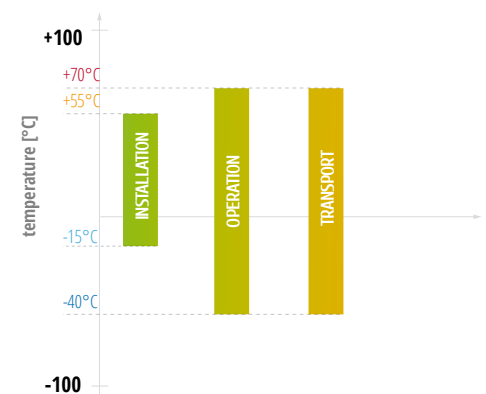

ARMORED SSC-T30I

ARMORED SSC-T30I

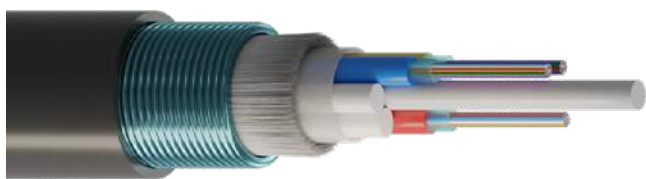

Telecom



Rodent Protection High



Duct



Direct buried

Cable structure

1. PE sheath (black) / option: LSOH (grey)
2. Corrugated steel tape
3. Fiberglass yarns
4. Loose tube (PBT) with optical fibers in filling compound
5. Ripcord

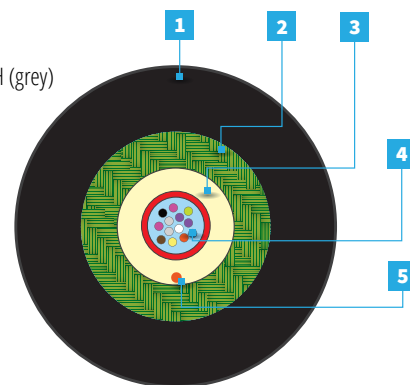

Configuration

ARMORED SSC-T30U									
Version	Fibers	Fibers per tube	Total elements	Active tubes	Ø ± 0.3	Nominal weight ±10% [kg/km]	Max. tensile load [N]		Crush [N/10 cm]
							al-lowed	static	
1T x 2-24F	2-24	2-24	1	1	7.6	69	1800	900	3000
1T x 2-24F LSOH	2-24	2-24	1	1	7.6	84	1800	900	

Other designs available on demand

Available colors

T-TELECOM (ACCORDING TO IEC 60304) - Fibers

1-12	1	2	3	4	5	6	7	8	9	10	11	12
Code	■	■	■	■	■	■	■	■	■	■	■	■
Color	red	green	blue	white	violet	orange	grey	yellow	brown	pink	black	aqua

T-TELECOM (ACCORDING TO IEC 60304) - Tubes

Tube	1	2	3	4	5	6	7	8	9	10	11	12
Code	■	■	■	■	■	■	■	■	■	■	■	■
Color	red	green	blue	white	violet	orange	grey	yellow	brown	pink	black	aqua

*In cable with a multi-layer construction color of the tubes will be repeated in second layer

**In case of lower fiber count some tubes can be replaced by fillers

Applications

- For installation into existing duct or directly buried
- Extreme rodent protection

Features

- Loose tube (PBT Ø 3.0mm) with filling compound
- Optical fibers
- Fibreglass yarns as strain relief
- Corrugated steel tape armouring
- UV stabilized PE sheath (black), option: LSOH sheath (grey by default, other colors available)

Operating temperature

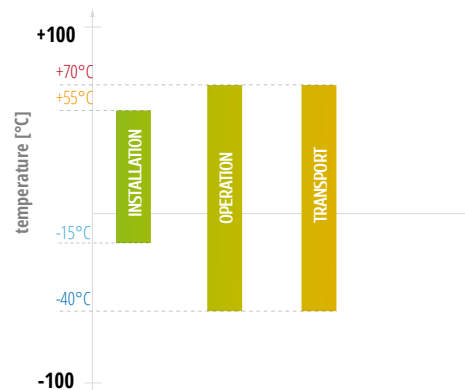

ARMORED DSC-CI



Telecom



Rodent Protection High



Duct



Direct buried

Configuration

TELECOM DUCT DSC-CI									
Version	Fibers	Fibers per tube	Total elements	Active modules	Ø ± 0.3	Nominal weight ±10% [kg/km]	Max. tensile load [N]		Crush [N/10 cm]
							al-lowed	static	
1-6T x 6F	6-36	6	6	1-6	11.4	168	2700	1400	4000
1-6T x 12F	12-72	12	6	1-6	11.4	169	2700	1400	
8T x 12F	96	12	8	8	13.2	203	2700	1400	
12T x 12F	144	12	12	12	16.4	269	2700	1400	
16T x 12F	192	12	16	16	16.8	237	2700	1400	
18T x 12F	216	12	18	18	16.8	238	2700	1400	
20T x 12F	240	12	24	20	18.6	290	2700	1400	
24T x 12F	288	12	24	24	18.6	290	2700	1400	

Other fiber counts available on demand

Available colors

T-TELECOM (ACCORDING TO IEC 60304) - Fibers

1-12	1	2	3	4	5	6	7	8	9	10	11	12
Code	■	■	■	■	■	■	■	■	■	■	■	■
Color	red	green	blue	white	violet	orange	grey	yellow	brown	pink	black	aqua

T-TELECOM (ACCORDING TO IEC 60304) - Tubes

Tube	1	2	3	4	5	6	7	8	9	10	11	12
Code	■	■	■	■	■	■	■	■	■	■	■	■
Color	red	green	blue	white	violet	orange	grey	yellow	brown	pink	black	aqua

*In cable with a multi-layer construction color of the tubes will be repeated in second layer

**In case of lower fiber count some tubes can be replaced by fillers

ARMORED DSC-CI

Cable structure

1. PE jacket
2. Corrugated steel tape
3. Fiberglass yarns
4. Water swellable yarns and tape
5. Central strength member (FRP)
6. Loose tube (PBT) with optical fibers in filling compound
7. Fillers
8. Ripcords

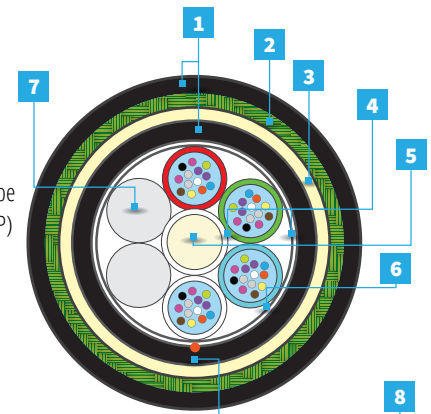

Applications

- For installation into existing duct or directly buried
- Extreme rodent protection

Features

- FRP strength and anti-buckling element
- Dry yarns and tape to prevent moisture into the cable
- Loose tube (PBT Ø 2.0mm) with filling compound
- Optical fibers
- Fillers (if applicable)
- Water-swellaable tape
- Fibreglass yarns as strain relief
- Corrugated steel tape armouring
- Double UV stabilized PE sheath
- Sheath options: LSOH, PA etc.

Operating temperature

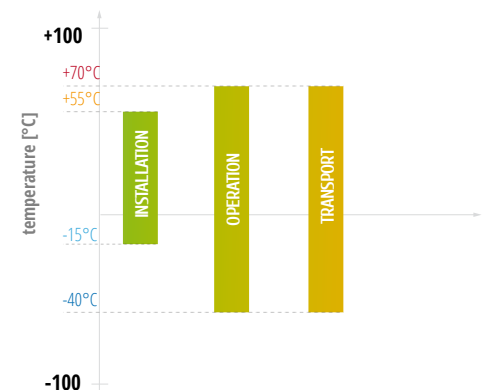

Telecom Aerial



Cable structure

1. LSOH outer sheath
2. Aramid yarns
3. Central semi tight buffer tube 900 µm with optical fiber

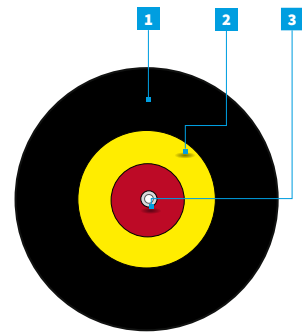

Configuration

AERO-DR03									
Version	Fibers	Fibers per tube	Total elements	Active tubes	∅ ± 5% [mm]	Nominal weight ±10% [kg/km]	Tensile load [N]		Crush [N/10 cm]
							allowed	static	
1F	1	1	1	1	3.0	9.5	300	100	3000

Other fiber counts available on demand

Available colors

T-TELECOM (ACCORDING TO IEC 60304) - Fibers in tube

1-12	1	2	3	4	5	6	7	8	9	10	11	12
Code												
Color	red	green	blue	white	violet	orange	grey	yellow	brown	pink	black	aqua
13-24	13	14	15	16	17	18	19	20	21	22	23	24
Code												
Color	red	green	blue	white	violet	orange	grey	yellow	brown	pink	natural	aqua

*In 24-fiber tube construction colors will be repeated to facilitate identification, fibers 13-24 will have rings every 25 cm

Applications

- For installation on poles
- Fully dielectric
- Aerial cable with aramid reinforcement

Features

- Semi tight buffer with 1 optical fiber (0.9 mm)
- Aramid yarns
- LSOH outer sheath

Operating temperature

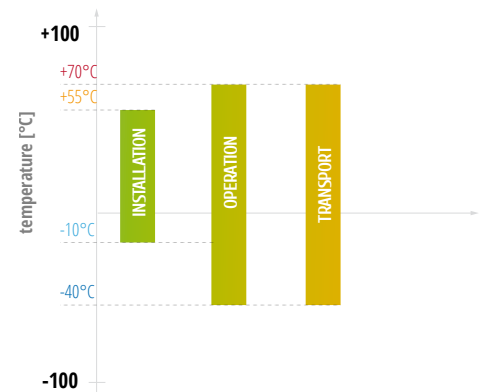

Ice: 0 mm Wind: 94.4 km/h

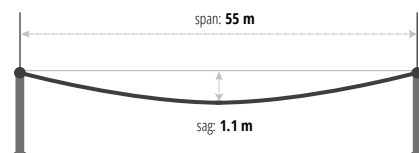

Ice: 3.0 mm Wind: 62.8 km/h

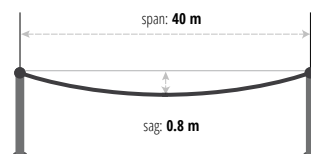

Ice: 4.0 mm Wind: 70 km/h

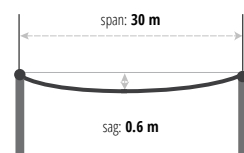



Cable structure

1. PE jacket
2. Ripcord
3. Water blocking yarns

4. Central loose tube (PBT) with 250 µm colored fibers in filling gel
5. FRP strength member

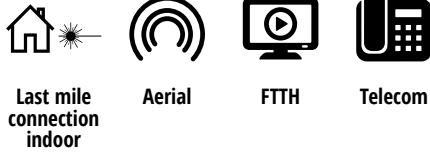
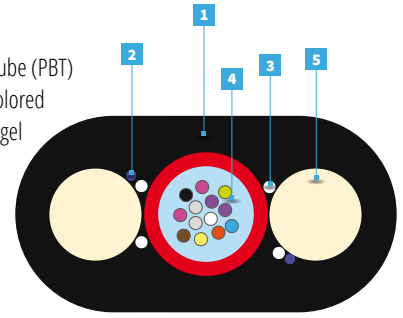

Cable variants

Version	AERO-DF03	AERO-DF03
Fiber count	1-12	16-24
Cable dimensions [mm]	8.3 x 4.6 (±3%)	8.7 x 5.0 (±3%)
Cable weight [kg/km]	37	38
Max. installation tension[N]	1300	1300

Mechanical and environmental characteristics

Parameter	
Crush performance	5000 N
Bending performance	10 cycles [20 x D]
Water Penetration	3 m sample, 1 m head, 24 h

Available colors

T-TELECOM (ACCORDING TO IEC 60304) - Fibers in tube

1-12	1	2	3	4	5	6	7	8	9	10	11	12
Code	■	■	■	■	■	■	■	■	■	■	■	■
Color	red	green	blue	white	violet	orange	grey	yellow	brown	pink	black	aqua
13-24	13	14	15	16	17	18	19	20	21	22	23	24
Code	■ ■	■ ■	■ ■	■ ■	■ ■	■ ■	■ ■	■ ■	■ ■	■ ■	■ ■	■ ■
Color	red	green	blue	white	violet	orange	grey	yellow	brown	pink	natural	aqua

*In 24-fiber tube construction colors will be repeated to facilitate identification, fibers 13-24 will have rings every 25 cm



NESC Light

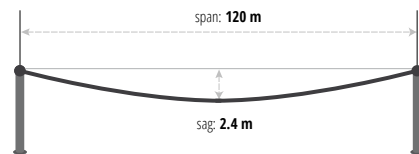

NESC Medium

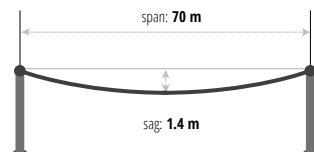

NESC Heavy

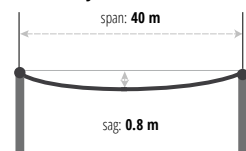

Applications

- Installation on poles or walls
- Can be installed in pipelines
- Fully dielectric cable

Features

- Loose tube with filling compound (PBT)
- Up to 24 fibers in a cable
- Two FRP strength elements
- Dry yarns to prevent moisture into cable
- Ripcord yarns For easy jacket removal
- PE UV resistant Jacket

Operating temperature

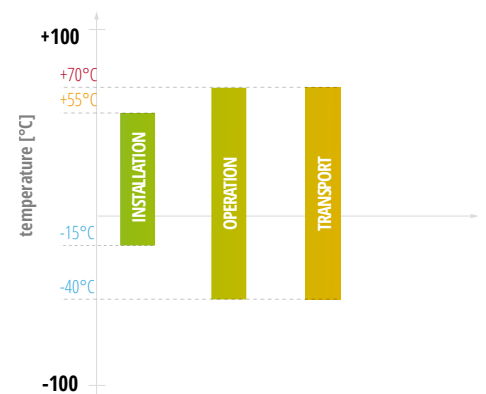



Cable structure

1. PE sheath
2. Ripcord
3. Water blocking yarns

4. Loose tube with filling compound
5. FRP rods reinforcement

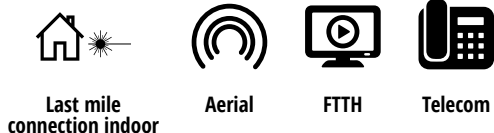
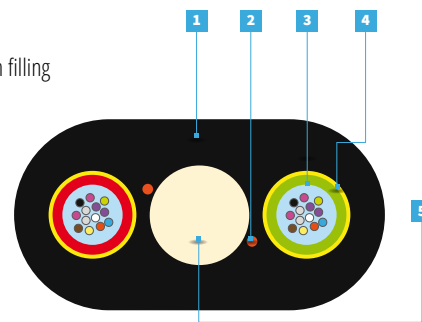

Cable variants

Version	AERO-DDF03
Fibre count [pcs]	4-48
Cable dimensions [mm]	9.3 x 4.8 (typically ±0.3 max 9.7 x 5.3)
Cable weight [kg/km]	50
Max. operational tension [N]	500
Max allowable tension [N]	1800

Mechanical and environmental characteristics

Parameter	
Crush performance	5000 N
Bending performance	10 cycles [20 x D]
Water Penetration	3 m sample, 1 m head, 24 h

Available colors

T-TELECOM (ACCORDING TO IEC 60304) - Fibers in tube

1-12	1	2	3	4	5	6	7	8	9	10	11	12
Code	■	■	■	■	■	■	■	■	■	■	■	■
Color	red	green	blue	white	violet	orange	grey	yellow	brown	pink	black	aqua
13-24	13	14	15	16	17	18	19	20	21	22	23	24
Code	■ ■	■ ■	■ ■	■ ■	■ ■	■ ■	■ ■	■ ■	■ ■	■ ■	■ ■	■ ■
Color	red	green	blue	white	violet	orange	grey	yellow	brown	pink	natural	aqua

*In 24-fiber tube construction colors will be repeated to facilitate identification, fibers 13-24 will have rings every 25 cm

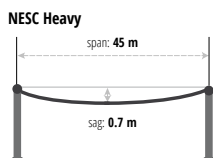
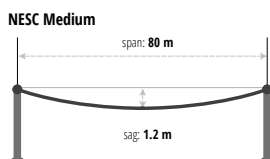
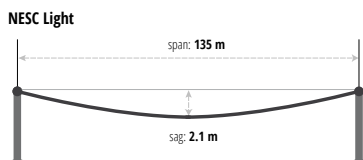

Applications

- Installation on poles or walls
- Can be installed in pipelines
- Fully dielectric cable

Features

- Loose tube with filling compound (PBT)
- Up to 24 fibers in a cable
- Two FRP strength elements
- Dry yarns to prevent moisture into cable
- Ripcord yarns for easy jacket removal
- PE UV resistant jacket

Operating temperature

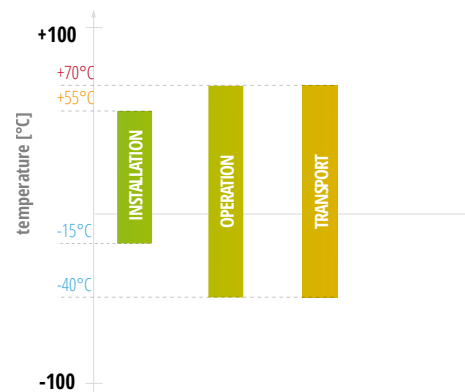



Cable structure

1. HDPE outer jacket
2. Aramid yarns
3. Central strength member (FRP)
4. Loose tubes (PBT) with colored fibers in filling gel
5. Water blocking yarns

6. Fillers
7. Water blocking tape
8. Ripcord

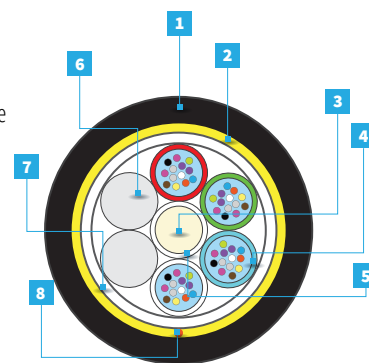

Telecom



Aerial



FTTH

Configuration

AERO-AS02 PBT TUBES 2.0 MM									
Version	Fibers	Fibers per tube	Total elements	Active tubes	Ø ± 5% [mm]	Nominal weight ±10% [kg/km]	Tensile load [N]		Crush [N/10 cm]
							allowed	static	
1-6T x 6F	6-36	6	6	1-6	10.0	73	2200	1200	2000
1-6T x 12F	12-72	12	6	1-6	10.0	75	2100	1000	
8T x 12F	96	12	8	8	11.3	98	2200	1100	
12T x 12F	144	12	12	12	13.8	143	2100	1000	

Other fiber counts available on demand

Applications

- Duct & pole mount
- High tensile and crush performance
- Fully dielectric cable
- Self-supporting aerial cable with aramid reinforcements

Features

- FRP strength and anti-buckling element
- Dry yarns to prevent moisture into the cable
- Loose tube (PBT Ø 2.0 mm) with filling compound
- 6-12 elements SZ stranded cable core
- Optical fibers
- Fillers (if applicable)
- Water-swallowable tape
- Aramid yarns as strain relief and water absorbent
- UV stabilized HDPE jacket

APPLICATION AND CABLE SPAN CHARACTERISTIC (for 6 tubes construction)

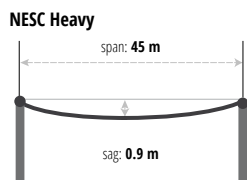
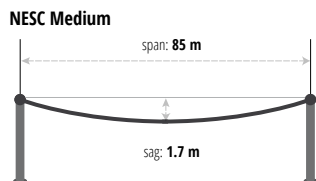
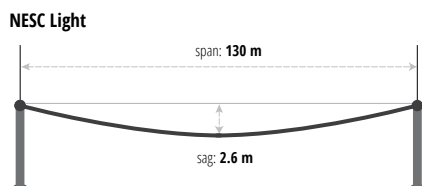

Operating temperature

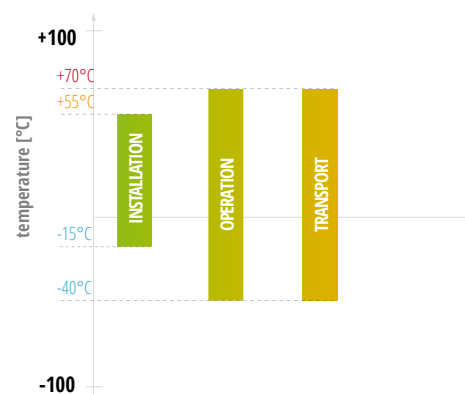



Cable structure

1. HDPE outer jacket
2. Aramid yarns
3. Central strength member (FRP)
4. Loose tubes (PBT) with colored fibers in filling gel
5. Water blocking yarns

6. Fillers
7. Water blocking tape
8. Ripcord

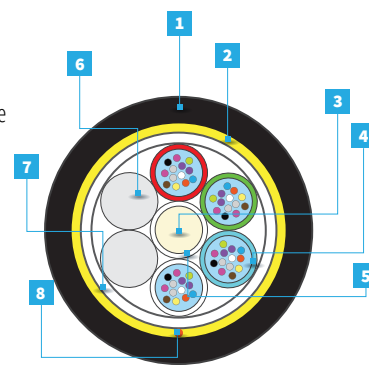

Telecom



Aerial



FTTH

Configuration

AERO-AS02 PBT TUBES 2.0 MM									
Version	Fibers	Fibers per tube	Total elements	Active tubes	Ø ± 5% [mm]	Nominal weight ±10% [kg/km]	Tensile load [N]		Crush [N/10 cm]
							allowed	static	
1-6T x 6F	6-36	6	6	1-6	10.0	75	3200	1800	2000
1-6T x 12F	12-72	12	6	1-6	10.1	77	3100	1500	
8T x 12F	96	12	8	8	11.3	100	3100	1500	
12T x 12F	144	12	12	12	13.8	146	3100	1500	

Other fiber counts available on demand

Available colors

T-TELECOM (ACCORDING TO IEC 60304) - Fibers

1-12	1	2	3	4	5	6	7	8	9	10	11	12
Code	■	■	■	■	■	■	■	■	■	■	■	■
Color	red	green	blue	white	violet	orange	grey	yellow	brown	pink	black	aqua

T-TELECOM (ACCORDING TO IEC 60304) - Tubes

Tube	1	2	3	4	5	6	7	8	9	10	11	12
Code	■	■	■	■	■	■	■	■	■	■	■	■
Color	red	green	blue	white	violet	orange	grey	yellow	brown	pink	black	aqua

*In case of lower fiber count some tubes can be replaced by fillers.



NESC Light

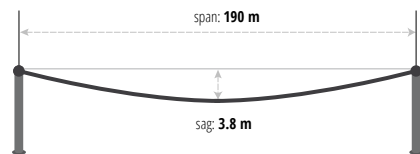

NESC Medium

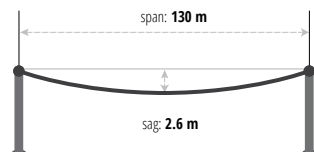

NESC Heavy

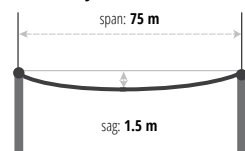

Applications

- Duct & pole mount
- High tensile and crush performance
- Fully dielectric cable
- Self-supporting aerial cable with aramid reinforcements

Features

- FRP strength and anti-buckling element
- Dry yarns to prevent moisture into the cable
- Loose tube (PBT Ø 2.0 mm) with filling compound
- 6-12 elements SZ stranded cable core
- Optical fibers
- Fillers (if applicable)
- Water-swellaable tape
- Aramid yarns as strain relief and water absorbent
- UV stabilized HDPE jacket

Operating temperature

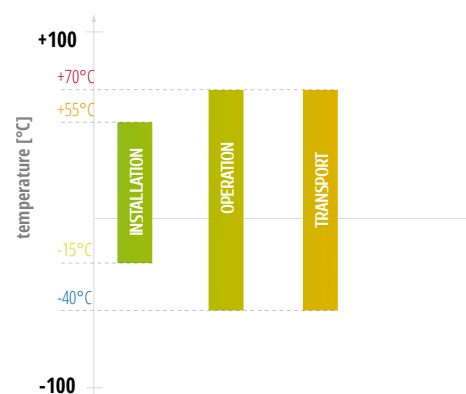

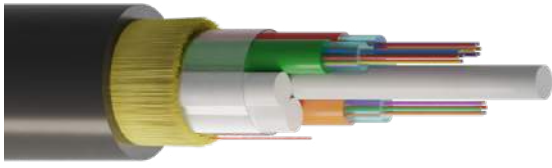

Cable structure

1. HDPE outer jacket
2. Aramid yarns
3. Central strength member (FRP)
4. Loose tubes (PBT) with colored fibers in filling gel
5. Water blocking yarns

6. Fillers
7. Water blocking tape
8. Ripcord

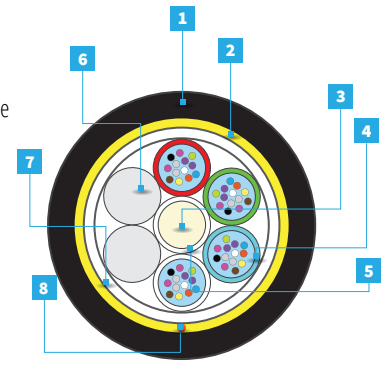

Telecom



Aerial



FTTH

Configuration

AERO-AS03 PBT TUBES 2.5 MM									
Version	Fibers	Fibers per tube	Total elements	Active tubes	Ø ± 5% [mm]	Nominal weight ±10% [kg/km]	Max. tensile load [N]		Crush [N/10 cm]
							instal-lation	opera-tion	
1-6T x 6F	6-36	6	6	1-6	11.4	97	3300	2200	3000
1-6T x 12F	12-72	12	6	1-6	11.4	98	3200	2100	
8T x 12F	96	12	8	8	13.0	127	3200	2100	
12T x 12F	144	12	12	12	16.1	193	3300	2200	

Other fiber counts available on demand

APPLICATION AND CABLE SPAN CHARACTERISTIC (for 6 tubes construction)

APPLICATION AND CABLE SPAN CHARACTERISTIC (for 6 tubes construction)

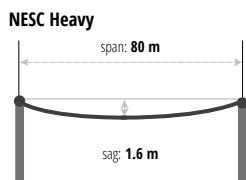
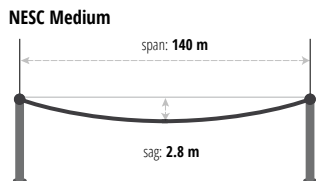
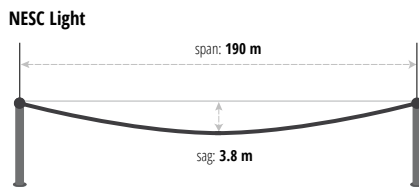

Applications

- Duct & pole mount
- High tensile and crush performance
- Fully dielectric cable
- Self-supporting aerial cable with aramid reinforcements

Features

- FRP strength and anti-buckling element
- Dry yarns to prevent moisture into the cable
- Loose tube (PBT Ø 2.0 mm) with filling compound
- 6-12 elements SZ stranded cable core
- Optical fibers
- Fillers (if applicable)
- Water-swellaable tape
- Aramid yarns as strain relief and water absorbent
- UV stabilized HDPE jacket

Operating temperature

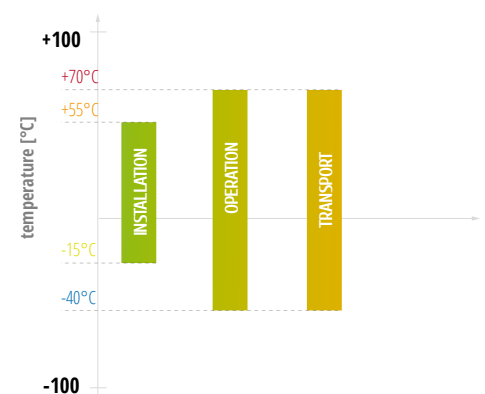



Cable structure

1. HDPE outer jacket
2. Aramid yarns
3. Central strength member (FRP)
4. Loose tubes (PBT) with colored fibers in filling gel
5. Water blocking yarns

6. Fillers
7. Water blocking tape
8. Ripcord

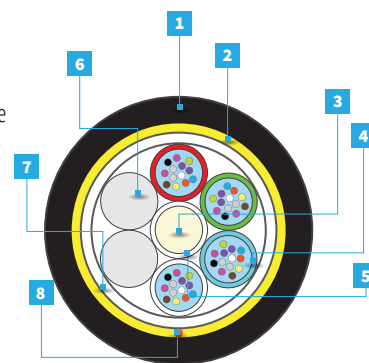

Telecom



Aerial



FTTH

Configuration

AERO-AS04 PBT TUBES 2.0 MM									
Version	Fibers	Fibers per tube	Total elements	Active tubes	Ø ± 5% [mm]	Nominal weight ±10% [kg/km]	Max. tensile load [N]		Crush [N/10 cm]
							installation	operation	
1T x 12F	12	12	6	1	10,1	75	4000	2000	2000
2T x 6F	12	6	6	2	10,1	75	4100	2400	
2T x 12F	24	12	6	2	10,1	76	4000	2000	
4T x 6F	24	6	6	4	10,1	76	4100	2400	
3T x 12F	36	12	6	3	10,1	80	4000	2000	
6T x 6F	36	6	6	6	10,1	76	4100	2400	
4T x 12F	48	12	6	4	10,1	80	4000	2000	
8T x 6F	48	6	8	8	11,3	97	4200	2500	
6T x 12F	72	12	6	6	10,1	82	4000	2000	
8T x 12F	96	12	8	8	11,4	103	4200	2100	
12T x 12F	144	12	12	12	13,9	149	4100	2000	

Other fiber counts available on demand

Applications

- Duct & pole mount
- High tensile and crush performance
- Fully dielectric cable
- Self-supporting aerial cable with aramid reinforcements

Features

- FRP strength and anti-buckling element
- Dry yarns to prevent moisture into the cable
- Loose tube (PBT Ø 2.0 mm) with filling compound
- 6-12 elements SZ stranded cable core
- Optical fibers
- Fillers (if applicable)
- Water-swellaable tape
- Aramid yarns as strain relief and water absorbent
- UV stabilized HDPE jacket

APPLICATION AND CABLE SPAN CHARACTERISTIC (for 6 tubes construction)



NESC Light

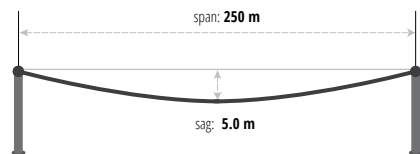

NESC Medium

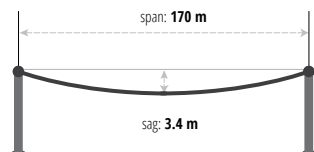

NESC Heavy

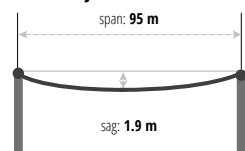

Operating temperature

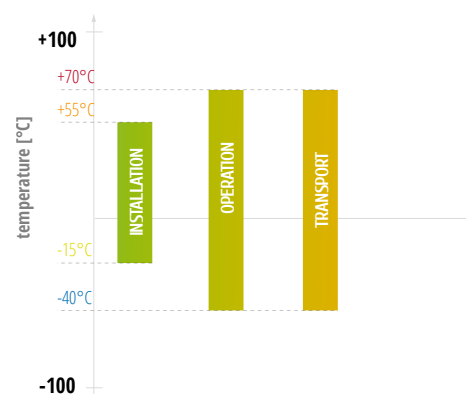

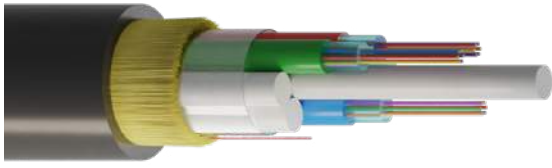

Cable structure

1. HDPE outer jacket
2. Aramid yarns
3. Central strength member (FRP)
4. Loose tubes (PBT) with colored fibers in filling gel
5. Water blocking yarns

6. Fillers
7. Water blocking tape
8. Ripcord

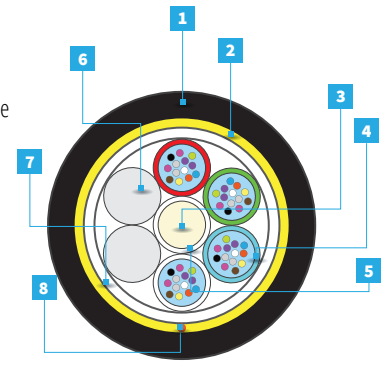

Telecom



Aerial



FTTH

Configuration

AERO-AS04 PBT TUBES 2.5 MM									
Version	Fibers	Fibers per tube	Total elements	Active tubes	Ø ± 5% [mm]	Nominal weight ±10% [kg/km]	Max. tensile load [N]		Crush [N/10 cm]
							installation	operation	
1-6T x 6F	6-36	6	6	1-6	11.4	98	4200	2900	3000
1-6T x 12F	12-72	12	6	1-6	11.4	99	4100	2600	
8T x 12F	96	12	8	8	13.1	128	4200	2800	
12T x 12F	144	12	12	12	16.2	194	4100	2700	

Other fiber counts available on demand

Applications

- Duct & pole mount
- High tensile and crush performance
- Fully dielectric cable
- Self-supporting aerial cable with aramid reinforcements

Features

- FRP strength and anti-buckling element
- Dry yarns to prevent moisture into the cable
- Loose tube (PBT Ø 2.5 mm) with filling compound
- 6-12 elements SZ stranded cable core
- Optical fibers
- Fillers (if applicable)
- Water-swellaable tape
- Aramid yarns as strain relief and water absorbent
- UV stabilized HDPE jacket

APPLICATION AND CABLE SPAN CHARACTERISTIC (for 6 tubes construction)

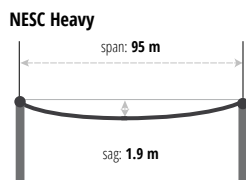
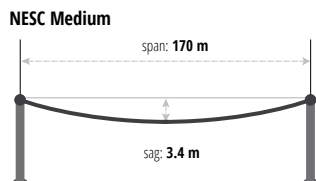
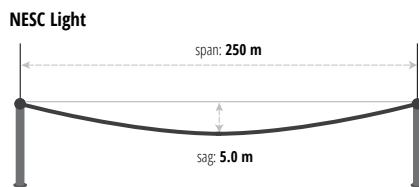

Operating temperature

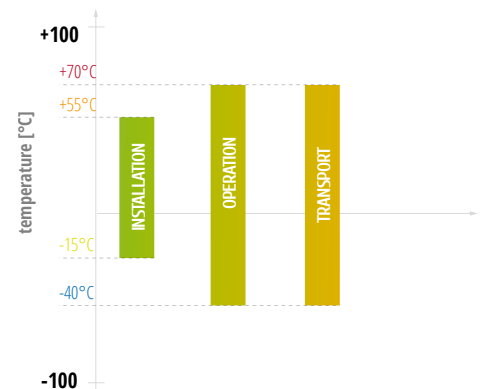



Telecom



Aerial



FTTH

Cable structure

1. HDPE outer jacket
2. Aramid yarns
3. Central strength member (FRP)
4. Loose tubes (PBT) with colored fibers in filling gel
5. Water blocking yarns

6. Fillers
7. Water blocking tape
8. Ripcord

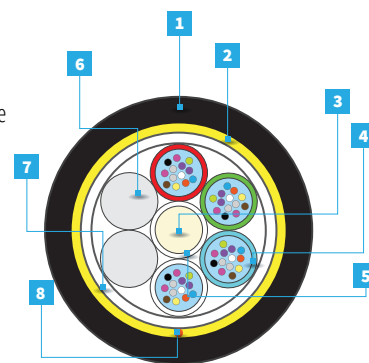

Configuration

AERO-AS06 PBT TUBES 2.0 MM									
Version	Qty			Active tubes	Ø ± 5% [mm]	Nominal weight ± 10% [kg/km]	Max. tensile load [N]		Crush [N/10 cm]
	Fibers	Fibers per tube	Total elements				instal-lation	opera-tion	
1-6T x 6F	6-36	6	6	1-6	10.2	82	6100	3600	2000
1-6T x 12F	12	12	6	1-6	10.3	88	6200	3000	
8T x 12F	96	12	8	8	11.5	110	6200	2800	
12T x 12F	144	12	12	12	13.9	154	6100	3000	

Other fiber counts available on demand

Applications

- Duct & pole mount
- High tensile and crush performance
- Fully dielectric cable
- Self-supporting aerial cable with aramid reinforcements

Features

- FRP strength and anti-buckling element
- Dry yarns to prevent moisture into the cable
- Loose tube (PBT Ø 2.0 mm) with filling compound
- 6-12 elements SZ stranded cable core
- Optical fibers
- Fillers (if applicable)
- Water-swellaable tape
- Aramid yarns as strain relief and water absorbent
- UV stabilized HDPE jacket

APPLICATION AND CABLE SPAN CHARACTERISTIC (for 6 tubes construction)

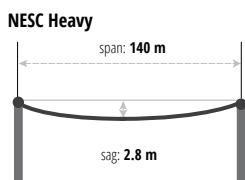
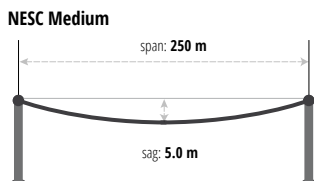
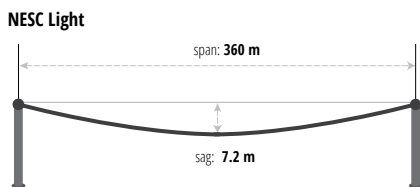

Operating temperature

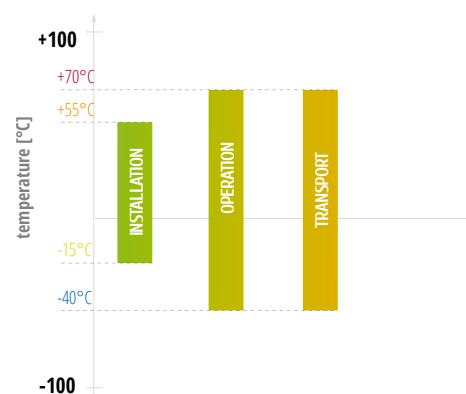

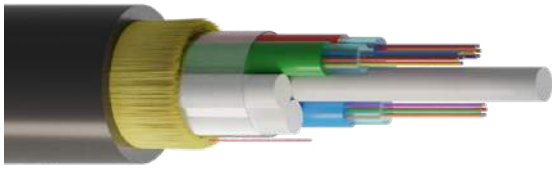

Cable structure

1. HDPE outer jacket
2. Aramid yarns
3. Central strength member (FRP)
4. Loose tubes (PBT) with colored fibers in filling gel
5. Water blocking yarns

6. Fillers
7. Water blocking tape
8. Ripcord

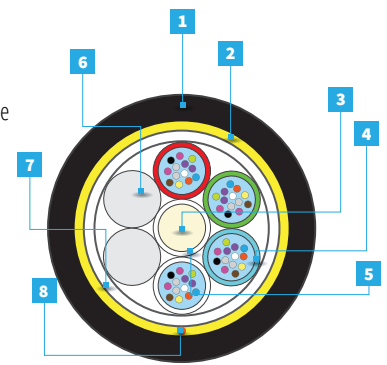

Telecom



Aerial



FTTH

Configuration

AERO-AS06 PBT TUBES 2.5 MM									
Version	Fibers	Fibers per tube	Total elements	Active tubes	Ø ± 5% [mm]	Nominal weight ±10% [kg/km]	Max. tensile load [N]		Crush [N/10 cm]
							installation	operation	
1-6T x 6F	6-36	6	6	1-6	11.6	101	6100	4200	3000
1-6T x 12F	12-72	12	6	1-6	11.6	104	6300	4100	
8T x 12F	96	12	8	8	13.2	132	6100	4000	
12T x 12F	144	12	12	12	16.2	198	6100	4000	

Other fiber counts available on demand

Applications

- Duct & pole mount
- High tensile and crush performance
- Fully dielectric cable
- Self-supporting aerial cable with aramid reinforcements

Features

- FRP strength and anti-buckling element
- Dry yarns to prevent moisture into the cable
- Loose tube (PBT Ø 2.5 mm) with filling compound
- 6-12 elements SZ stranded cable core
- Optical fibers
- Fillers (if applicable)
- Water-swellable tape
- Aramid yarns as strain relief and water absorbent
- UV stabilized HDPE jacket

APPLICATION AND CABLE SPAN CHARACTERISTIC (for 6 tubes construction)

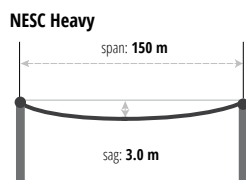
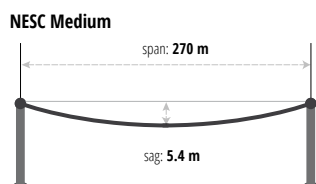
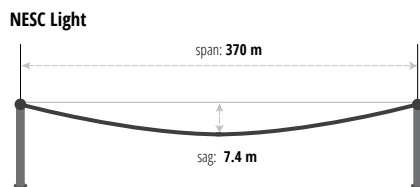

Operating temperature

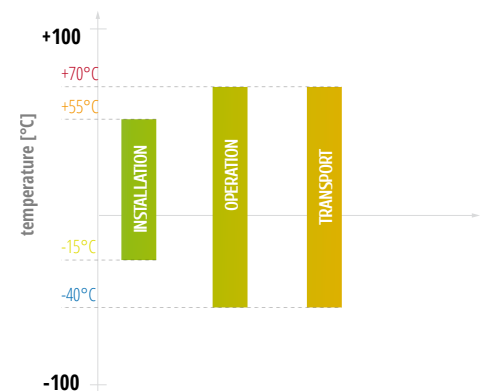



Telecom



Aerial



FTTH

Cable structure

1. HDPE outer jacket
2. Aramid yarns
3. Central strength member (FRP)
4. Loose tubes (PBT) with colored fibers in filling gel
5. Water blocking yarns

6. Fillers
7. Water blocking tape
8. Ripcord

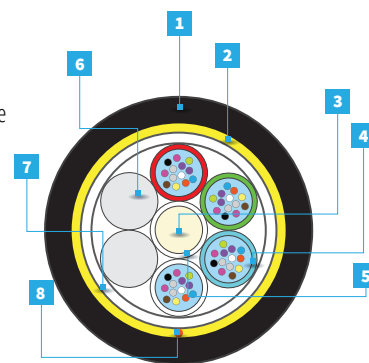

Configuration

AERO-AS09 PBT TUBES 2.5 MM									
Version	Qty			Active tubes	Ø ± 5% [mm]	Nominal weight ± 10% [kg/km]	Max. tensile load [N]		Crush [N/10 cm]
	Fibers	Fibers per tube	Total elements				instal-lation	opera-tion	
1-6T x 6F	6-36	6	6	1-6	11.6	101	9300	6600	3000
1-6T x 12F	12-72	12	6	1-6	11.7	104	9200	6000	
8T x 12F	96	12	8	8	13.2	138	9200	6100	
12T x 12F	144	12	12	12	16.2	203	9200	6100	

Other fiber counts available on demand

Applications

- Duct & pole mount
- High tensile and crush performance
- Fully dielectric cable
- Self-supporting aerial cable with aramid reinforcements
- UV resistant

Features

- FRP strength and anti-buckling element Ø 2.5 mm
- Optical fibers
- Loose tube with filling compound (PBT Ø 2.5 mm)
- 6-12 elements SZ stranded cable core
- Dry yarns to prevent moisture into cable
- Aramid yarns as tensile elements

APPLICATION AND CABLE SPAN CHARACTERISTIC (for 6 tubes construction)

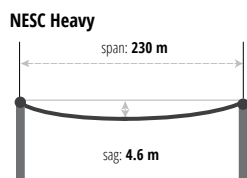
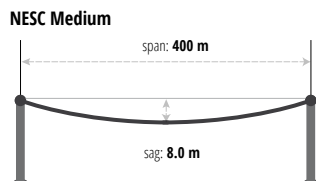
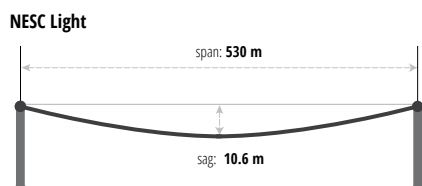

Operating temperature

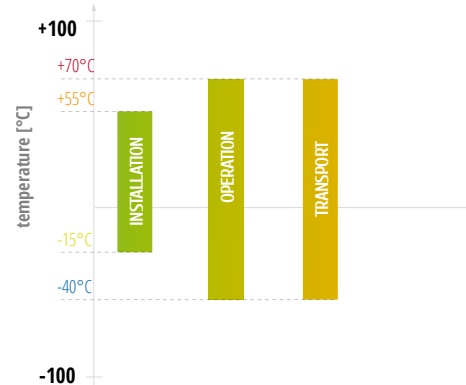

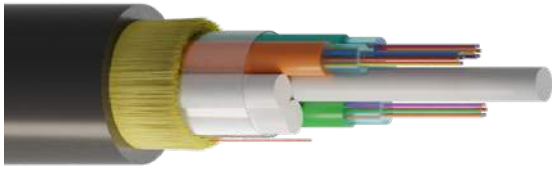

Cable structure

1. HDPE outer jacket
2. Aramid yarns
3. Central strength member (FRP)
4. Loose tubes (PBT) with colored fibers in filling gel
5. Water blocking yarns

6. Fillers
7. Water blocking tape
8. Ripcord

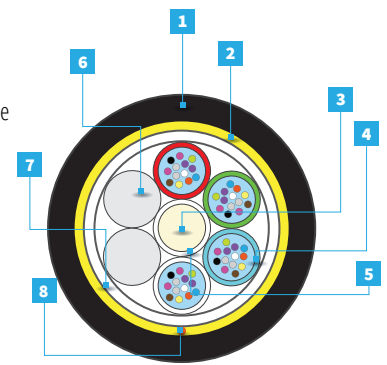

Telecom



Aerial



FTTH

Configuration

AERO-AS12 PBT TUBES 2.5 MM									
Version	Fibers	Fibers per tube	Total elements	Active tubes	Ø ± 5% [mm]	Nominal weight ±10% [kg/km]	Max. tensile load [N]		Crush [N/10 cm]
							installation	operation	
1-6T x 6F	6-36	6	6	1-6	11.7	106	12700	9000	3000
1-6T x 12F	12-72	12	6	1-6	11.8	110	12500	8000	
8T x 12F	96	12	8	8	13.3	143	12200	7800	
12T x 12F	144	12	12	12	16.3	208	12100	8000	

Other fiber counts available on demand

Applications

- Duct & pole mount
- High tensile and crush performance
- Fully dielectric cable
- Self-supporting aerial cable with aramid reinforcements
- UV resistant

Features

- FRP strength and anti-buckling element
- Optical fibers
- Loose tube with filling compound (PBT Ø 2.5 mm)
- 6-12 elements SZ stranded cable core
- Dry yarns to prevent moisture into cable
- Aramid yarns as tensile elements

APPLICATION AND CABLE SPAN CHARACTERISTIC (for 6 tubes construction)

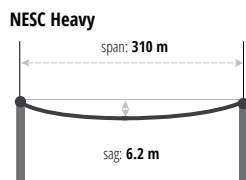
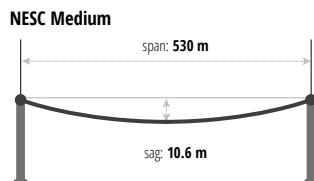
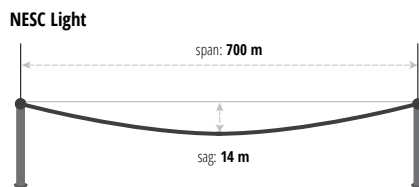

Operating temperature

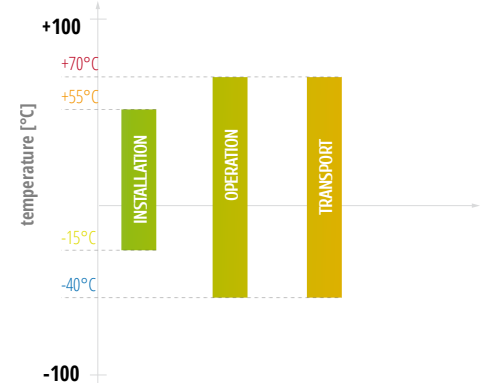

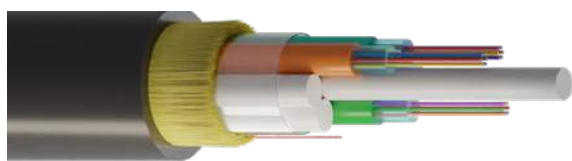

Telecom



Aerial



FTTH

Cable structure

1. HDPE outer jacket
2. Aramid yarns
3. Central strength member (FRP)
4. Loose tubes (PBT) with colored fibers in filling gel
5. Water blocking yarns

6. Fillers
7. Water blocking tape
8. Ripcord

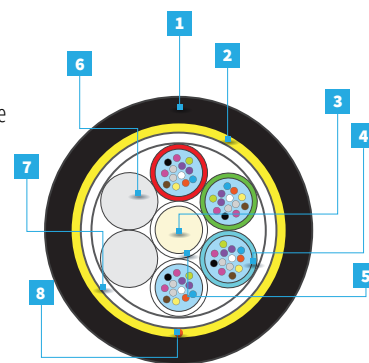

Configuration

AERO-AS14 PBT TUBES 2.5 MM									
Version	Qty			Active tubes	Ø ± 5% [mm]	Nominal weight ± 10% [kg/km]	Max. tensile load [N]		Crush [N/10 cm]
	Fibers	Fibers per tube	Total elements				instal-lation	opera-tion	
1-6T x 6F	6-36	6	6	1-6	11.8	109	14400	10100	3000
1-6T x 12F	12-72	12	6	1-6	11.8	113	14500	9400	
8T x 12F	96	12	8	8	13.4	147	14200	9100	
12T x 12F	144	12	12	12	16.4	211	14000	9200	

Other fiber counts available on demand

Applications

- Duct & pole mount
- High tensile and crush performance
- Fully dielectric cable
- Self-supporting aerial cable with aramid reinforcements
- UV resistant

Features

- FRP strength and anti-buckling element
- Optical fibers
- Loose tube with filling compound (PBT Ø 2.5 mm)
- 6-12 elements SZ stranded cable core
- Dry yarns to prevent moisture into cable
- Aramid yarns as tensile elements

APPLICATION AND CABLE SPAN CHARACTERISTIC (for 6 tubes construction)

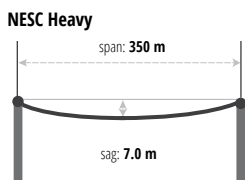
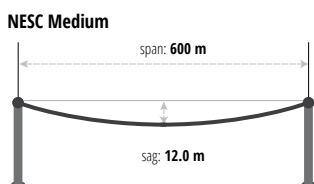
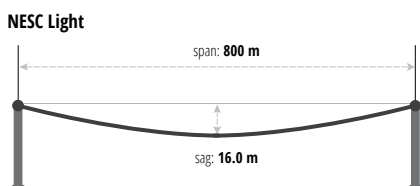

Operating temperature

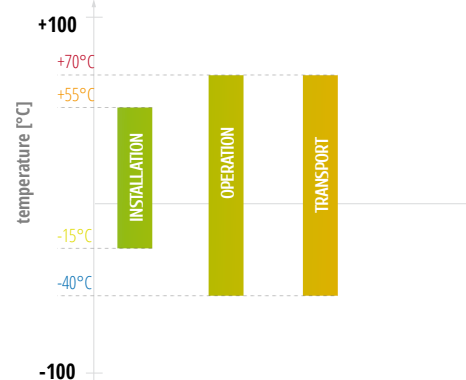



Special Cable Designs

SPECIAL DESIGN FTTA-DAC

SPECIAL DESIGN FTTA-DAC



Cable structure

1. Outer jacket PE
2. Fiberglass yarns
3. Loose tube (PBT) with colored fibers in filling gel
4. Ripcords
5. Embedded strength members (FRP)



FTFA



Aerial



Hi-crush



Compact design

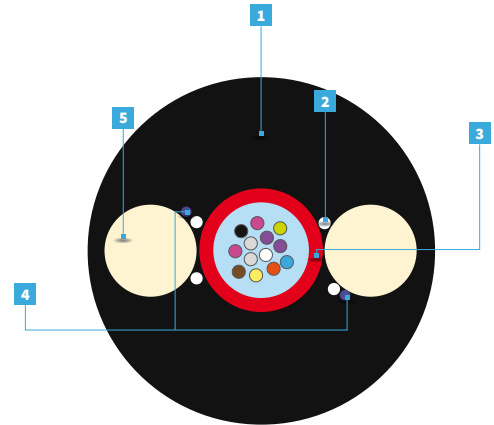

Configuration

FTFA-DAC							
Version	Fibers	Fibers per tube	Ø ± 5% [mm]	Nominal weight ±10% [kg/km]	Max. tensile load [N]		Crush [N/10 cm]
					installation	operation	
1T x 2F	2	2	5.8	31	800 (ε=0.33%) 1200 (ε=0.50%)	250	3500
1T x 4F	4	4	5.8	31			
1T x 6F	6	6	5.8	31			
1T x 8F	8	8	5.8	32			
1T x 12F	12	12	5.8	32			
1T x 24F	24	24	6.3	38			

Applications

- Fiber to the antenna system (FTFA)
- Optical access cable with fiber glass yarns reinforcement
- Direct buried construction
- Fully dielectric cable
- Last mile connection

Available colors

T-TELECOM (ACCORDING TO IEC 60304) - Fibers

1-12	1	2	3	4	5	6	7	8	9	10	11	12
Code	■	■	■	■	■	■	■	■	■	■	■	■
Color	red	green	blue	white	violet	orange	grey	yellow	brown	pink	black	aqua
13-24	13	14	15	16	17	18	19	20	21	22	23	24
Code	■	■	■	■	■	■	■	■	■	■	■	■
Color	red	green	blue	white	violet	orange	grey	yellow	brown	pink	natural	aqua

*In 24-fiber tube construction colors will be repeated to facilitate identification, fibers 13-24 will have rings every 25 cm

Features

- Fiberglass yarns as water-blocking and strain relief elements
- Loose tube (PBT) with filling compound
- Optical fibers
- Embedded strength members (FRP)

Operating temperature

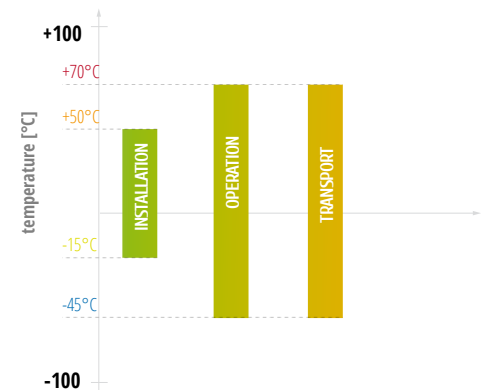

HYBRID POWER+FO BDC-CIP 1.5 MM²

HYBRID CABLES *BDC-CIP 1.5 mm²*

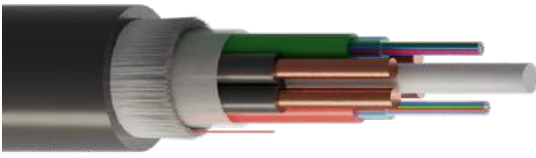

Cable structure

1. HDPE outer jacket
2. Fiberglass yarns
3. Loose tubes (PBT) with colored fibers in filling gel
4. Water blocking yarns on FRP

5. Water blocking tape
6. Central strength member (FRP)
7. 1.5 mm² Cu – insulated copper wire
8. Ripcord

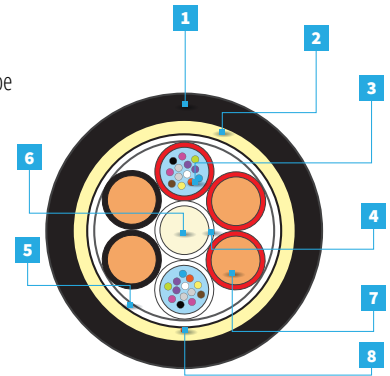

FTTH



Duct



Rodent Protection Basic



Hybrid FO+Power

Configuration

BDC-CIP 1.5 MM ²									
Version	Fibers	Fibers per tube	Total elements	Active tubes	Ø ± 5% [mm]	Nominal weight ± 10% [kg/km]	Max. tensile load [N]		Crush [N/10 cm]
							allowed	static	
1T x 12F +2x1.5 mm ²	12	12	6	1	10.7	127	2700	1300	2700
1T x 12F +4x1.5 mm ²	12	12	6	1	10.7	170	2700	1300	
2T x 12F +1x1.5 mm ²	24	12	6	2	10.7	107	2700	1300	
2T x 12F +2x1.5 mm ²	24	12	6	2	10.7	128	2700	1300	
2T x 12F +4x1.5 mm ²	24	12	6	2	10.7	171	2700	1300	
3T x 12F +2x1.5 mm ²	36	12	6	3	10.7	129	2700	1300	
4T x 12F +2x1.5 mm ²	48	12	6	4	10.7	130	2700	1300	
1T x 12F +6x1.5 mm ²	12	12	8	1	12.1	231	2700	1300	
2T x 12F +6x1.5 mm ²	24	12	8	2	12.1	232	2700	1300	
3T x 12F +4x1.5 mm ²	36	12	8	3	12.1	190	2700	1300	
4T x 12F +4x1.5 mm ²	48	12	8	4	12.1	191	2700	1300	

Other fiber and copper wire counts available on demand

Technical copper wire characteristics

Max DC resistance	12,1±0,2 Ω/km@20°C
Electric strength	3400 V DC/1 minute
Current carrying capacity	7A
Operating voltage	65V AC/DC
Conductor material	Bare copper
Conductor cross section	1,5mm ²
Insulated conductor dia.	2,2mm
Insulation material	PVC

Applications

- Installation into existing ducts or directly buried
- High tensile and crush performance

Features

- FRP strength and anti-buckling element
- Loose tube with filling compound (PBT Ø 2.2mm)
- Tubes with copper core
- Dry yarns to prevent moisture into the cable
- UV stabilized HDPE jacket
- LSOH, PA etc Jacket option

Operating temperature

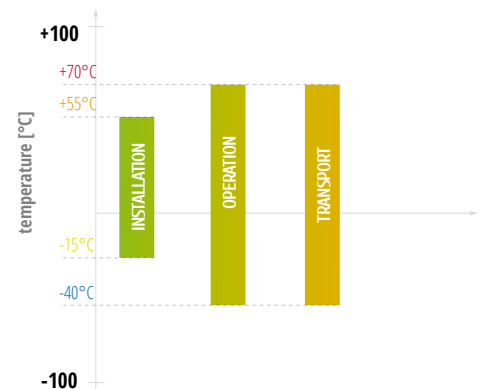

HYBRID POWER+FO BDC-CIP 0.5 MM² H05V-U

HYBRID CABLES *BDC-CIP 0.5 mm²*



FTTH



Duct



Rodent Protection Basic



Hybrid FO+Power

Cable structure

1. HDPE outer jacket
2. Fiberglass yarns
3. Loose tubes (PBT) with colored fibers in filling gel
4. Water blocking yarns on FRP

5. Water blocking tape
6. Central strength member (FRP)
7. 0.5 mm² Cu – insulated copper wire
8. Ripcord

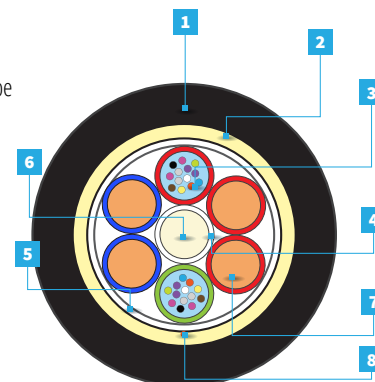

Configuration

BDC-CIP 0.5 MM ² H05V-U									
Version	Fibers	Fibers per tube	Total elements	Active tubes	Ø ± 5% [mm]	Nominal weight ± 10% [kg/km]	Max. tensile load [N]		Crush [N/10 cm]
							allowed	static	
1T x 12F +2x0.5 mm ²	12	12	6	1	10.1	89	2700	1000	2700
1T x 12F +4x0.5 mm ²	12	12	6	1	10.1	105	2700	1000	
1T x 12F +5x0.5 mm ²	12	12	6	1	10.1	113	2700	1000	
2T x 12F +2x0.5 mm ²	24	12	6	2	10.1	90	2700	1000	
2T x 12F +4x0.5 mm ²	24	12	6	2	10.1	106	2700	1000	
3T x 12F +2x0.5 mm ²	36	12	6	3	10.1	91	2700	1000	
4T x 12F +2x0.5 mm ²	48	12	6	4	10.1	92	2700	1000	
5T x 12F +1x0.5 mm ²	60	12	6	5	10.1	85	2700	1000	
1T x 12F +6x0.5 mm ²	12	12	8	1	11.4	127	2800	1100	
2T x 12F +6x0.5 mm ²	24	12	8	2	11.4	128	2800	1100	
4T x 12F +4x0.5 mm ²	48	12	8	4	11.4	120	2800	1100	

Other fiber and copper wire counts available on demand

Applications

- For installation into existing duct or directly buried
- High tensile and crush performance

Features

- FRP strength and anti-buckling element
- Insulated copper cores 0.5 mm² (Ø 2.0 mm)
- Loose tubes with filling compound (PBT Ø 2.0 mm)
- Tape and dry yarns to prevent moisture into the cable
- Fiberglass yarns as strain relief elements
- UV stabilized HDPE outer jacket
- Other outer jackets materials available

Operating temperature

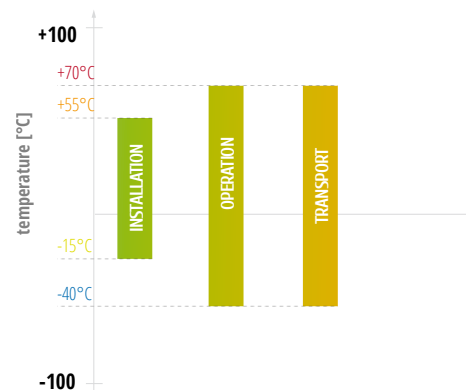

Technical copper wire characteristics

Max DC resistance	36,0 Ω/km@20°C
Conductor material	Bare copper
Conductor cross section	0.5 mm ²
Insulated conductor dia.	2.0 mm
Insulation material	PVC

HYBRID POWER+FO BDC-CIP 0.75 MM² H05V-U

HYBRID CABLES *BDC-CIP 0.75 mm²*



FTTH



Duct



Rodent Protection Basic



Hybrid FO+Power

Cable structure

1. HDPE outer jacket
2. Fiberglass yarns
3. Loose tubes (PBT) with colored fibers in filling gel
4. Water blocking yarns on FRP
5. Water blocking tape
6. Central strength member (FRP)
7. 0.75 mm² Cu – insulated copper wire
8. Ripcord

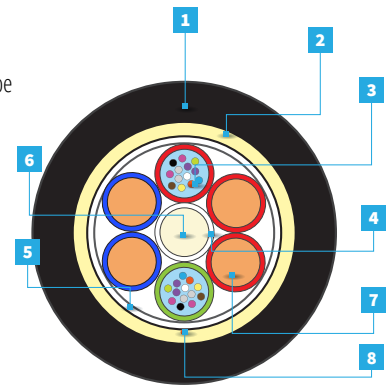

Configuration

BDC-CIP 0.75 MM ² H05V-U									
Version	Fibers	Fibers per tube	Total elements	Active tubes	Ø ± 5% [mm]	Nominal weight ±10% [kg/km]	Max. tensile load [N]		Crush [N/10 cm]
							allowed	static	
1T x 12F +2x0.75 mm ²	12	12	6	1	10.7	99	2700	1300	2700
1T x 12F +4x0.75 mm ²	12	12	6	1	10.7	114	2700	1300	
2T x 12F +2x0.75 mm ²	24	12	6	2	10.7	100	2700	1300	
2T x 12F +4x0.75 mm ²	24	12	6	2	10.7	115	2700	1300	
3T x 12F +2x0.75 mm ²	36	12	6	3	10.7	101	2700	1300	
4T x 12F +2x0.75 mm ²	48	12	6	4	10.7	102	2700	1300	
1T x 12F +6x0.75 mm ²	12	12	8	1	12.1	147	2700	1300	
2T x 12F +6x0.75 mm ²	24	12	8	2	12.1	148	2700	1300	
3T x 12F +4x0.75 mm ²	36	12	8	3	12.1	134	2700	1300	
4T x 12F +4x0.75 mm ²	48	12	8	4	12.1	135	2700	1300	

Other fiber and copper wire counts available on demand

Technical copper wire characteristics	
Max DC resistance	24.0 Ω/km@20°C
Conductor material	Bare copper
Conductor cross section	0.75 mm ²
Insulated conductor dia.	2.2 mm
Insulation material	PVC

Applications

- For installation into existing duct or directly buried
- High tensile and crush performance

Features

- FRP strength and anti-buckling element
- Insulated copper cores 0.75mm² (Ø 2.2mm)
- Loose tubes with filling compound (PBT Ø 2.2mm)
- Tape and dry yarns to prevent moisture into the cable
- Fiberglass yarns as strain relief elements
- UV stabilized HDPE outer jacket
- Other outer jackets materials available

Operating temperature

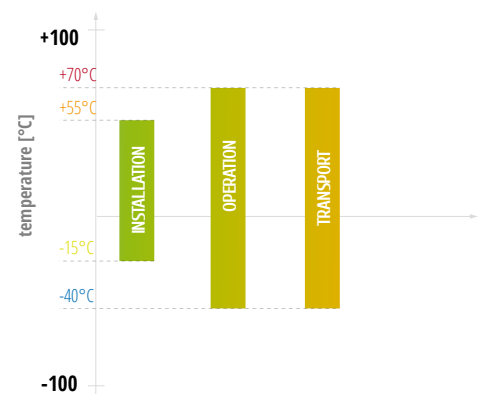

HYBRID POWER+FO BDC-CIP 1.00 MM² H05V-U

HYBRID CABLES *BDC-CIP 1.00 mm²*



FTTH



Duct



Rodent Protection Basic



Hybrid FO+Power

Cable structure

1. HDPE outer jacket
2. Fiberglass yarns
3. Loose tubes (PBT) with colored fibers in filling gel
4. Water blocking yarns on FRP
5. Water blocking tape
6. Central strength member (FRP)
7. 1.0 mm² Cu – insulated copper wire
8. Ripcord

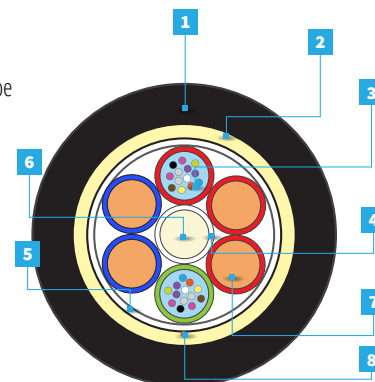

Configuration

BDC-CIP 1.0 MM ² H05V-U									
Version	Fibers	Fibers per tube	Total elements	Active tubes	Ø ± 5% [mm]	Nominal weight ± 10% [kg/km]	Max. tensile load [N]		Crush [N/10 cm]
							allowed	static	
1T x 12F +2x1.00 mm ²	12	12	6	1	10.7	104	2700	1300	2700
1T x 12F +4x1.00 mm ²	12	12	6	1	10.7	124	2700	1300	
2T x 12F +2x1.00 mm ²	24	12	6	2	10.7	105	2700	1300	
2T x 12F +4x1.00 mm ²	24	12	6	2	10.7	125	2700	1300	
3T x 12F +2x1.00 mm ²	24	12	6	2	10.7	125	2700	1300	
4T x 12F +2x1.00 mm ²	48	12	6	4	10.7	107	2700	1300	
5T x 12F +1x1.00 mm ²	60	12	6	5	10.7	98	2700	1300	
1T x 12F +6x1.00 mm ²	12	12	8	1	12.1	162	2700	1300	
1T x 12F +6x1.00 mm ²	12	12	8	1	12.1	162	2700	1300	
2T x 12F +6x1.00 mm ²	24	12	8	2	12.1	163	2700	1300	
3T x 12F +4x1.00 mm ²	36	12	8	3	12.1	144	2700	1300	
3T x 12F +4x1.00 mm ²	36	12	8	3	12.1	144	2700	1300	
4T x 12F +4x1.00 mm ²	48	12	8	4	12.1	145	2700	1300	

Other fiber and copper wire counts available on demand

Applications

- For installation into existing duct or directly buried
- High tensile and crush performance

Features

- FRP strength and anti-buckling element
- Insulated copper cores 1.00 mm² (Ø 2.3 mm)
- Loose tubes with filling compound (PBT Ø 2.2 mm)
- Tape and dry yarns to prevent moisture into the cable
- Fiberglass yarns as strain relief elements
- UV stabilized HDPE outer jacket
- Other outer jackets materials available

Operating temperature

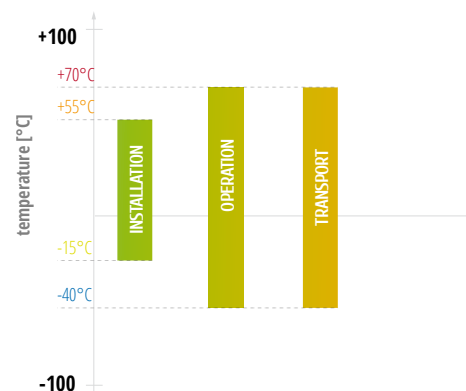

Technical copper wire characteristics	
Max DC resistance	18.1 Ω/km@20°C
Conductor material	Bare copper
Conductor cross section	1.00 mm ²
Insulated conductor dia.	2.3 mm
Insulation material	PVC

HYBRID POWER+FO BDC-DIP 1.5 MM² H07V-U

HYBRID CABLES *BDC-DIP 1.5 mm²*

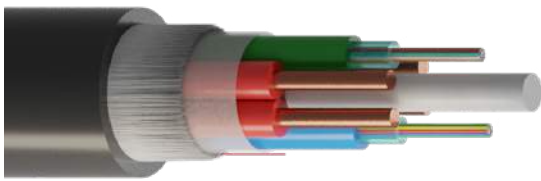

Cable structure

1. HDPE outer jacket
2. Fiberglass yarns
3. Loose tubes (PBT) with colored fibers in filling gel
4. Water blocking yarns on FRP

5. Water blocking tape
6. Central strength member (FRP)
7. 1.5 mm² Cu – insulated copper wire
8. Ripcord

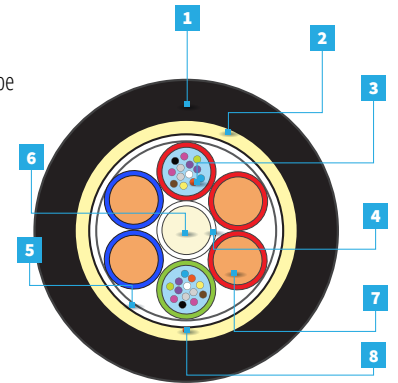

FTTH



Duct



Rodent Protection Basic



Hybrid FO+Power

Configuration

BDC-DIP 1.5 MM ² H07V-U									
Version	Fibers	Fibers per tube	Total elements	Active tubes	Ø ± 5% [mm]	Nominal weight ±10% [kg/km]	Max. tensile load [N]		Crush [N/10 cm]
							allowed	static	
1T x 12F +2x1.5 mm ²	12	12	6	1	12.4	137	2700	1500	2700
1T x 12F +4x1.5 mm ²	12	12	6	1	12.4	166	2700	1500	
2T x 12F +2x1.5 mm ²	24	12	6	2	12.4	138	2700	1500	
2T x 12F +4x1.5 mm ²	24	12	6	2	12.4	167	2700	1500	
3T x 12F +2x1.5 mm ²	36	12	6	3	12.4	140	2700	1500	
4T x 12F +2x1.5 mm ²	48	12	6	4	12.4	141	2700	1500	
5T x 12F +1x1.5 mm ²	60	12	6	5	12.4	128	2700	1500	
1T x 12F +6x1.5 mm ²	12	12	8	1	14.2	228	3000	1800	
2T x 12F +6x1.5 mm ²	24	12	8	2	14.2	229	3000	1800	
3T x 12F +4x1.5 mm ²	36	12	8	3	14.2	202	3000	1800	
4T x 12F +4x1.5 mm ²	48	12	8	4	14.2	203	3000	1800	

Other fiber and copper wire counts available on demand

Technical copper wire characteristics	
Max DC resistance	12.1 Ω/km@20°C
Conductor material	Bare copper
Conductor cross section	1.5 mm ²
Insulated conductor dia.	2.8 mm
Insulation material	PVC

Applications

- For installation into existing duct or directly buried
- High tensile and crush performance

Features

- FRP strength and anti-buckling element
- Insulated copper cores 1.50 mm² (Ø 2.8 mm)
- Loose tubes with filling compound (PBT Ø 2.8 mm)
- Tape and dry yarns to prevent moisture into the cable
- Fiberglass yarns as strain relief elements
- UV stabilized HDPE outer jacket
- Other outer jackets materials available

Operating temperature

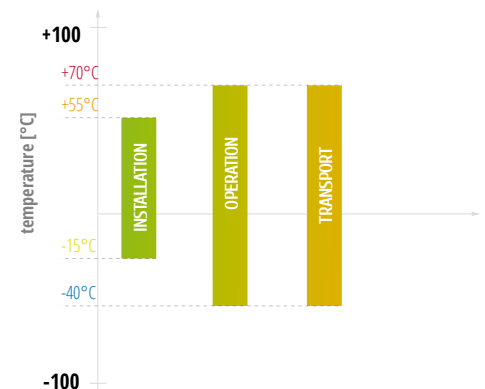

HYBRID POWER+FO BDC-DIP 2.5 MM² H07V-U

HYBRID CABLES *BDC-DIP 2.5 mm²*



FTTH



Duct



Rodent Protection Basic



Hybrid FO+Power

Cable structure

1. HDPE outer jacket
2. Fiberglass yarns
3. Loose tubes (PBT) with colored fibers in filling gel
4. Water blocking yarns on FRP
5. Water blocking tape
6. Central strength member (FRP)
7. 2.5 mm² Cu – insulated copper wire
8. Ripcord

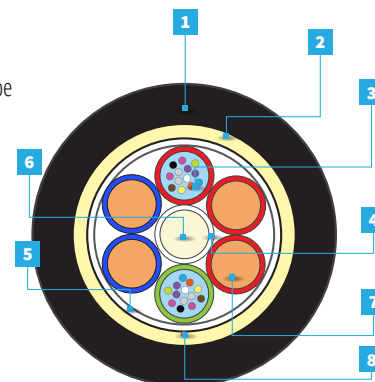

Configuration

BDC-DIP 2.5 MM ² H07V-U									
Version	Fibers	Fibers per tube	Total elements	Active tubes	Ø ± 5% [mm]	Nominal weight ± 10% [kg/km]	Max. tensile load [N]		Crush [N/10 cm]
							allowed	static	
1T x 12F + 2x2.5 mm ²	12	12	6	1	13.7	175	2800	1700	2700
1T x 12F + 4x2.5 mm ²	12	12	6	1	13.7	223	2800	1700	
2T x 12F + 2x2.5 mm ²	24	12	6	2	13.7	177	2800	1700	
2T x 12F + 4x2.5 mm ²	24	12	6	2	13.7	225	2800	1700	
3T x 12F + 2x2.5 mm ²	36	12	6	3	13.7	179	2800	1700	
4T x 12F + 2x2.5 mm ²	48	12	6	4	13.7	180	2800	1700	
5T x 12F + 1x2.5 mm ²	60	12	6	5	13.7	158	2800	1700	
1T x 12F + 6x2.5 mm ²	12	12	8	1	15.7	311	2800	1700	
2T x 12F + 6x2.5 mm ²	24	12	8	2	15.7	313	2800	1700	
3T x 12F + 4x2.5 mm ²	36	12	8	3	15.7	267	2800	1700	
4T x 12F + 4x2.5 mm ²	48	12	8	4	15.7	268	2800	1700	

Other fiber and copper wire counts available on demand

Technical copper wire characteristics

Max DC resistance	7.41 Ω/km@20°C
Conductor material	Bare copper
Conductor cross section	2.5 mm ²
Insulated conductor dia.	3.3 mm
Insulation material	PVC

Applications

- For installation into existing duct or directly buried
- High tensile and crush performance

Features

- FRP strength and anti-buckling element
- Insulated copper cores 2.50 mm² (Ø 3.3 mm)
- Loose tubes with filling compound (PBT Ø 3.2 mm)
- Tape and dry yarns to prevent moisture into the cable
- Fiberglass yarns as strain relief elements
- UV stabilized HDPE outer jacket
- Other outer jackets materials available

Operating temperature

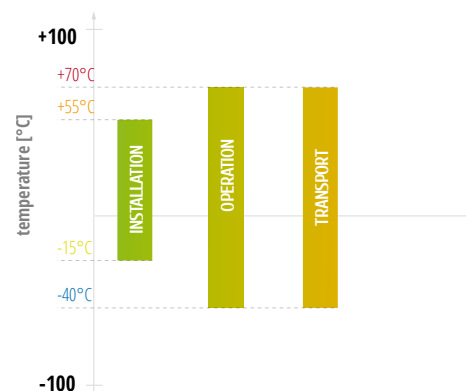

HYBRID POWER+FO BDC-DID 0.8 MM

HYBRID CABLES *BDC-DID 0.8 mm*

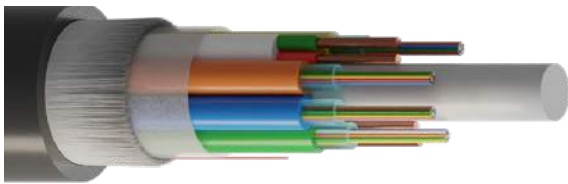

Cable structure

1. HDPE outer jacket
2. Fiberglass yarns
3. Loose tubes (PBT) with colored fibers in filling gel
4. Water blocking yarns on FRP

5. Water blocking tape
6. Central strength member (FRP)
7. 2x Ø 0.8/1.3 insulated Cu pair
8. Ripcord

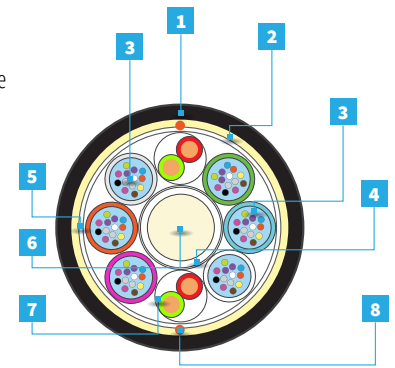

FTTH



Duct



Rodent Protection Basic



Hybrid FO+Power

Configuration

BDC-DID 0.8 MM									
Version	Fibers	Fibers per tube	Total elements	Active tubes	Ø ± 5% [mm]	Nominal weight ±10% [kg/km]	Max. tensile load [N]		Crush [N/10 cm]
							allowed	static	
1T x 12F + 7x2x0,8Cu	12	12	8	1	13.1	162	2900	1900	2000
2T x 12F + 6x2x0,8Cu	24	12	8	2	13.1	161			
3T x 12F + 5x2x0,8Cu	36	12	8	3	13.1	160			
4T x 12F + 4x2x0,8Cu	48	12	8	4	13.1	158			
5T x 12F + 3x2x0,8Cu	60	12	8	5	13.1	157			
6T x 12F + 2x2x0,8Cu	72	12	8	6	13.1	156			
7T x 12F + 1x2x0,8Cu	84	12	8	7	13.1	154			

Applications

- For installation into existing duct or directly buried
- High tensile and crush performance

Features

- FRP strength and anti-buckling element
- Insulated copper pairs 2xØ 0.8/1.3 mm
- Loose tubes with filling compound (PBT Ø 2.5 mm)
- Tape and dry yarns to prevent moisture into the cable
- Fiberglass yarns as strain relief elements
- UV stabilized HDPE outer jacket
- Other outer jackets materials available

Other fiber and copper wire counts available on demand

Technical copper wire characteristics	
Standard	PN-EN 50290-1-1:2002
Maximum resistance of wire loop	75 Ω/km@20°C
Insulation resistance	1500 MΩ·km
Material of conductor	Copper
Nominal diameter of conductor	0.8 mm
Nominal diameter of insulation	1.3 mm
Insulation material	PE

Operating temperature

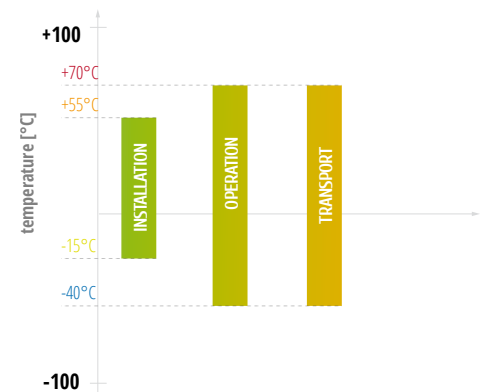

NOTES

A series of horizontal dashed lines for taking notes.

FIBRAIN SP. Z O.O.

Rogoźnica 312
36-060 Głogów Małopolski
Poland
phone: (+48) 17 866-08-14
fax: (+48) 17 866-08-11
e-mail: info@fibrain.com

FIBRAIN MÉXICO

Paseo de la Reforma 250 / Piso 9
Esquina c/Niza, Col. Juárez
Del. Cuahémoc
México D.F. 06600
phone: (+52) 55 3600 7546
e-mail: info@fibrain.com.mx

www.fibrain.com

FIBRAIN ®